

4H1145  
Rev. 2011 – Destroy Previous Versions

---

# 4-H HORSE & PONY PROJECT SHOW RULES & REGULATIONS



4-H Youth Development  
Institute for Children & Youth  
Michigan State University Extension

4H1145

Rev. 2011 – Destroy Previous Versions

---

# 4-H HORSE & PONY PROJECT SHOW RULES & REGULATIONS



**4-H Youth Development  
Institute for Children & Youth  
Michigan State University Extension**

# Contents

**Preface**..... iii

**General Rules** ..... 1

**Guidelines for Ring Stewards** ..... 7

**Fitting & Showing Division** ..... 8

**Halter Division** ..... 16

**Longe Line Division** ..... 18

**English Riding Division** ..... 20

English Appointments..... 20

English Classes ..... 21

    Open English Pleasure ..... 21

    English Saddle Seat ..... 21

        Saddle Seat Equitation ..... 21

        Saddle Seat Pleasure ..... 24

    Gaited Pleasure ..... 24

    English Hunter Seat Classes..... 26

        Hunter Seat Equitation on the Flat ..... 27

        Hunter Seat Equitation Over Fences..... 29

        Hunter Under Saddle (Hunter Seat Pleasure) ..... 31

        Working Hunter Over Fences ..... 31

        Baby Green Over Fences ..... 34

        Hunter Hack..... 34

    Bareback English Equitation..... 35

**Sidesaddle Division**..... 38

Sidesaddle Equitation..... 39

Sidesaddle Pleasure..... 41

**Dressage Division** ..... 42

Suitable to Become a Dressage Horse ..... 48

Dressage Seat Equitation..... 48

**Western Riding Division** ..... 55

Western Appointments ..... 55

    Western Bits ..... 55

Gaits ..... 58

Western Classes ..... 59

    Stock Seat Equitation (Western Horsemanship) ..... 59

    Bareback Western Equitation ..... 61

    Western Pleasure ..... 62

Western Snaffle Bit..... 63

**Reining Division** ..... 65

**English/Western Division** ..... 71

Lead Line Equitation..... 71

Walk-Trot Equitation ..... 71

English/Western Trail Class ..... 72

English/Western Riding Class ..... 76

**Driving Division** ..... 81

Reinsmanship (Driving Equitation) ..... 81

Pleasure Driving ..... 82

Fine Harness Horse..... 83

Roadster to Bike ..... 84

**Gymkhana Division** ..... 86

General Gymkhana Rules ..... 86

Gymkhana Classes ..... 88

    Barrel Bending ..... 88

    Cloverleaf Barrel Race ..... 89

    Indiana Flag Race ..... 90

    Keyhole..... 91

    Pole Bending ..... 92

    Speed & Action ..... 92

**Draft Horse Division** ..... 94

Draft Horse Classes ..... 94

    Draft Horse Fitting & Showing ..... 94

    Showmanship Decorating..... 97

    Draft Horse Pleasure Driving..... 97

    Draft Horse Driving Reinsmanship ..... 99

    Draft Horse Driving Working Class Single ..... 100

**Glossary** ..... 103

**Appendix: Suggested Changes Form** ..... 106

**Note:** Information that appears in a gray box, like this, has been changed in or added to this version of the rule book.

## Preface

These 4-H horse and pony project uniform rules are written to standardize the judging and evaluation of 4-H horse shows throughout Michigan. The rules were developed to promote consistency within the program and will be followed at the State 4-H Horse Show. For more horse and pony project rules at the county level, please contact your county MSU Extension 4-H staff. (You can usually find your county MSU Extension office in the business or government pages of your telephone book under your county name.) We intend with this publication to provide educational information about the various types of horses and classes represented in the Michigan 4-H horse and pony project.

We appreciate the help of USA Equestrian in developing this guide. Rules from USA Equestrian are copyrighted and are reprinted here with their permission. We thank the American Quarter Horse Association, the Pinto Horse Association of America, the Pony of the Americas Club, the National Snaffle Bit Association, the National Reining Horse Association, the Racking Horse Breeders Association of America, the International Side Saddle Organization, the Tennessee Walking Horse Breeder and Exhibitors Association and the Palomino Horse Breeders of America for the use of excerpts from their rulebooks. Thanks also to all of the Michigan 4-H horse program volunteers and participants who developed and worked on previous editions of this book.

This book was edited by Rebecca McKee, editor, 4-H Youth Development, Michigan State University Extension. It was designed and illustrated by Marian Reiter, graphic designer, 4-H Youth Development, Michigan State University Extension, and by Abbey Warren Miller, communications manager and graphic designer, Michigan 4-H Foundation.

Special thanks to former Equine Extension Youth specialists Kelly Boles Chapman and Stacey Doumit, who worked on this book, as well as to members of the State 4-H Horse Show Rules and Regulations Committee and the 4-H Horse Judges Advisory Committee for their tireless efforts. If we have left anyone out, it is unintentional, as the efforts of all are greatly appreciated.

Karen L. Waite  
Equine Extension Specialist  
Department of Animal Science  
Michigan State University

## General Rules

1. In this book, "horse" refers to all equine, including ponies, mules and donkeys.

### Safety

2. The primary responsibility for the safety of the exhibitor rests with the exhibitor and with his or her parent or legal guardian. A judge may excuse any unsafe vehicle or equipment or any unruly horse from competition.

3. **Protective headgear** – All participants in all hunter (both over fences and on the flat) and gymkhana classes are required to wear properly secured protective riding helmets whenever they are mounted. The helmets must meet the specifications of the American Society for Testing and Materials (ASTM), must be manufactured and distributed by a participant in the certification program of the Safety Equipment Institute (SEI) and must bear the SEI certification label (SEI F1163 or above). The exhibitor (or his or her parent or legal guardian if the exhibitor is a minor) – not the local show officials or judge – is solely responsible for complying with the headgear rule. Show officials reserve the right to spot-check helmets at any time to verify compliance with this rule.

It is highly recommended that all 4-H members participating in horse shows, practice events and any other riding activity wear protective headgear. There will be no discrimination against protective headgear, even if the style does not match the style of riding. Harnesses must be secured and must properly fit the head. A well-fitted helmet should stay on the rider's head when the rider bends over at the waist and shakes his or her head from side to side.

4. In all western, English and gymkhana classes, tying or securing the rider or any part of the rider in the saddle or to any other equipment is unsafe. Such action will disqualify the rider.

5. The size of a horse should be suitable to the size of its exhibitor, and the temperament of the horse should be equal to its exhibitor's ability.

### Age Policies

6. "4-H age" will be determined by a young person's age as of January 1 of the 4-H program year (which runs from September 1 through August 31). Exhibitor's ages for statewide 4-H activities are determined by their ages on January 1 of the current calendar year.

### Cloverbuds (5- to 8-Year-Olds)

7. All 4-H cloverbud activities (for 5- to 8-year-olds) must follow guidelines set by the State 4-H Office. Please check with your county 4-H staff for details. When younger children (aged 5 to 8) are involved in the 4-H horse project, all adults and older children must be aware

of the youngsters' safety. It is suggested that 5- to 8-year-olds learn about horses using activities that keep them safe and foster long-term interest in and excitement about the project. Extra adults should be on hand to help 5- to 8-year-olds before classes and as spotters during classes.

**8.** ASTM-SEI-approved safety helmets must be worn by youth aged 5 to 8.

**9.** It is important to remember that recognition of children aged 5 to 8 must be developmentally appropriate. Children aged 5 to 8 must not be put into competitive situations and must not be ranked. It is appropriate, however, to recognize the child's participation. It is also appropriate that a caring, nurturing adult provide the child with information about the strengths of his or her project and where the 4-H'er might improve the project. Please contact your county 4-H staff for a copy of the Michigan 4-H Youth Development Cloverbud Policy or see [web1.msue.msu.edu/msue/cyf/youth/downloads/4-HCloverbudPolicy.pdf](http://web1.msue.msu.edu/msue/cyf/youth/downloads/4-HCloverbudPolicy.pdf).

**10.** Five- and 6-year-olds are eligible for leadline experiences with animals on a halter and lead. They must be directly assisted one-on-one by a parent, guardian or adult volunteer who is on the ground holding the animal's halter or lead to maximize safety. When 5- and 6-year-olds are working with horses, assistance must be provided by adults on foot, rather than mounted on other horses.

**11.** Off-lead, walk-trot experiences may be appropriate activities for children aged 7 and 8, with adult volunteers in the ring with the children at all times.

## Animal Ownership

**12.** 4-H members are encouraged to work with horses they or their families own. Animal ownership is encouraged but not required. An animal does not have to be registered in the member's name. However, an animal must be in the 4-H member's continual care as much as possible and must be designated as the member's project animal by the specified county deadline. County deadlines may not be later than May 1 for an exhibitor to be eligible for the State 4-H Horse Show.

## Breed Class Requirements

**13.** All registered horses shown in breed classes must meet the requirements of their breed associations. 4-H horse projects embrace the use of different breeds and, while 4-H has general standards, judges should recognize show ring competence that follows the standards of the breeds being shown. Judges are expected to be familiar with all breed standards.

## Stallions

**14.** Stallions can only be shown during the calendar year in which they are foaled.

## Performance Requirements

**15.** It is strongly recommended that judges use pattern work to place at least the top individuals in horsemanship and equitation classes. Patterns shall be worked in championship showmanship, equitation and horsemanship classes.

**16.** If patterns are used, railwork is optional.

**17.** In performance classes, judges should specify the gait to be used after calling for a reverse. If a judge does not specify a gait, riders must continue in the same gait used before the reverse. A reverse should not be called for at a canter or lope during rail work.

**18.** In all classes where backing is required, the judge may require only finalists in the class to back their horses.

**19.** Judges may require exhibitors (dismounted) to drop the bit for inspection before or at the conclusion of any class.

## Equipment Breakdowns, Animal Lameness & Falls

**20.** Judges will examine and check all horses brought into any class for lameness. This is essential. Obvious lameness shall be cause for disqualification. Obvious lameness is:

- Consistently observable at a trot under all circumstances.
- Marked nodding, hitching or shortened stride.
- Minimal weight-bearing in motion or at rest; inability to move.

**21.** If tack or equipment breaks or a horse loses a shoe and the exhibitor cannot safely complete the class or course, he or she may be disqualified. However, if the exhibitor is able to continue the course despite the difficulty and without cruelty to the horse and without causing a safety hazard, the exhibitor may continue and complete the class or course.

**22.** A competitor is considered to have fallen when he or she is separated from the horse in such a way as to necessitate remounting or vaulting into the saddle. A horse is considered to have fallen when, at the same time, its shoulder and hip on the same side have touched either the ground, or an obstacle and the ground.

## Appointments of Horse & Rider

**23.** Exhibitors and judges should remember at all times that entries are to be judged on ability rather than on personal attire.

**24.** Contestants must be penalized for incomplete appointments. The penalty will depend on the nature and extent of the omissions or the

inappropriateness of the appointments. Formal evening clothes are inappropriate for daytime classes.

**25.** Tack and equipment with silver ornaments is not preferred over good, solid, clean, properly fitted working equipment. Flowers and veils (except as noted under appointments) and dangling jewelry are not acceptable.

**26. Protective headgear** – See General Rule 3 for complete information on protective headgear. It is highly recommended that all 4-H members participating in horse shows, practice events and any other riding activity wear protective headgear. There will be no discrimination against protective headgear, even if the style does not match the style of riding. Harnesses must be secured and must properly fit the head.

**27. Footwear** – 4-H members should always wear boots designed for horseback riding when handling or riding horses at 4-H events. Tennis shoes, sandals and flip-flops are not acceptable.

**28. Numbers** – Exhibitors must display a visible number or numbers in all classes. Shows are encouraged to use numbers only, without letters. Any exhibitor failing to display a number or displaying the wrong number will be penalized at the judge's discretion.

### Sportsmanship, Fair Play & Humane Treatment of Animals

**29.** If a situation arises that is not covered specifically by this rule book, USA Equestrian rules may be used as a guideline. If USA Equestrian rules do not address the issue, AQHA (American Quarter Horse Association) rules may be used as a guideline.

**30.** Good sportsmanship is to be displayed at all times by all exhibitors, their families and spectators. Good sportsmanship is defined as respectful treatment of judges, show management, other competitors, and all horses and other animals involved. In addition, respect for the tradition of the sport and spirit of showing horses is paramount. Any individual not displaying good sportsmanship may be disqualified or excused from the event at the discretion of the judge or governing body of the event.

**31.** Overt coaching from outside the arena will be penalized at the judge's discretion.

**32.** No person on the show grounds may treat a horse in an inhumane manner. The show grounds include, but are not limited to, the barns, stalls, practice areas and show arenas.

When a report or discovery of inhumane treatment is made, county show management will investigate the incident and report it to the appropriate authorities and MSU Extension staff. The standard for measuring conduct or treatment is that which a reasonable person,

informed and experienced in generally accepted equine training procedures, would determine to be cruel, abusive and inhumane.

**33.** Exhibited animals should not be excessively thin or fat but should demonstrate a Body Condition Score of 4 or greater, as determined by the Henneke Body Condition Scoring System. For more information on Body Condition Scoring visit [www.extension.org/horse](http://www.extension.org/horse) and search on "horse body condition scoring."

**34.** All equine-related state laws are to be followed at 4-H events. Counties or specific events may have additional health guidelines, and it is the responsibility of the exhibitor's family to be aware of these.

### Height Measurements

**35.** When measuring the height of a 4-H project horse:

**a.** Stand the animal on a smooth, level surface so the front legs are vertical and the back of the hocks are in a vertical line with the point of the horse's hip (see fig. 1).

**b.** Hold the animal's head only low enough to reveal the highest point of the withers and no lower. With the horse in this position, measure the vertical distance from the highest point of the withers to the ground.

**c.** Place the arm of the measuring standard over the highest point of the withers; no measurement taken at any other part of the horse's body shall be accepted.

The standard shall be a straight, rigid official measuring stick and should be provided with a plumb bob or spirit level to make sure the

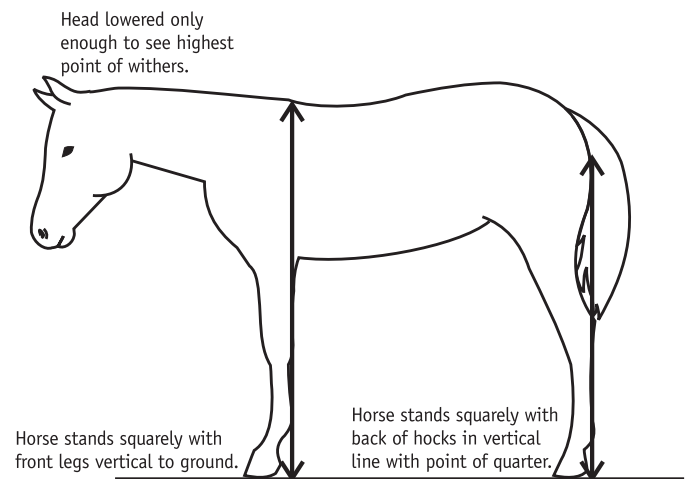

Figure 1. Measuring a horse.

## GENERAL RULES

standard is perpendicular from the withers to the ground and that the crosspiece is parallel to the ground.

Ponies must measure 56 inches or less at the withers. Shod ponies will be allowed  $\frac{1}{2}$  inch for the thickness of the shoes.

**35.** Miniature horses will be measured in accordance with American Miniature Horse Registry (AMHR) guidelines.

## GUIDELINES FOR RING STEWARDS

### Guidelines for Ring Stewards

The ring steward is best described as the judge's assistant. He or she works with the judge, the announcer, the gate person and the exhibitors to ensure that the show runs smoothly and efficiently. The duties of the ring steward include:

1. Meeting with the judge, the announcer, the show chairperson, committee members or superintendents as soon as possible before the show begins. Any special rules applying to the show should be discussed. The number of entries at which classes will be split, and who is to be responsible for keeping track of them, should be decided.
2. Carrying a copy of the show classes, 4-H rules (this book) and any special rules for the show. The ring steward should help keep the judge informed of the type of class being judged.
3. Knowing when all of the entrants in a class have entered the arena and checking for scratches.
4. Helping keep the ring safe by watching for unruly or unsafe horses and asking the judge to excuse them.
5. Paying special attention to young and or inexperienced exhibitors and helping to keep them safe.
6. Working with the judge, the announcer and the arena gate person to help keep classes moving.
7. Being as courteous as possible to all involved. However, the ring steward should not "visit over the fence" with spectators, with exhibitors or with the judge.
8. Staying out of the judge's line of vision.
9. Not helping the judge place the class in any way.
10. Acting as a buffer between the judge and the exhibitors and spectators.
11. A 4-H ring steward should have showing experience and should at least be a 4-H teen aged 13 and up.

# Fitting & Showing Division

In judging 4-H fitting and showing classes, judges should emphasize the exhibitors' ability to handle and show their horses and to recognize breed customs, with safety as the major consideration.

The horse's conformation is not judged, since the horse is considered a means of displaying the exhibitor's abilities.

The judge or show management will designate a pattern to demonstrate the exhibitor's ability to handle and show the horse to greatest advantage. Patterns are not limited to the examples provided in this publication.

**APPOINTMENTS OF HORSE** – Tack must be clean, neat, supple and properly fitted. Appointments of the horse for the various divisions follow.

- **Western** – Horse must be shown in a halter. The use of a chain end lead shank with the chain under the horse's jaw or over the horse's nose is permitted for safety reasons.

- **English (saddle-seat type)** – Horse may be shown in a bridle if over age 2. (**Exception:** Arabians may be shown in a suitable show halter at any age.) The snaffle rein should be removed or secured to the mane at the withers. Whips or crops may be used with discretion.

- **English (hunter-seat type)** – Horse may be shown in a bridle (snaffle, kimberwick or pelham) if over age 2. A plain leather halter with throat latch is also acceptable.

- **Draft Horses and Mules** – See the Draft Horse Division for information on fitting and showing for draft horses, mammoth donkeys and heavy mules.

**APPOINTMENTS OF EXHIBITOR** – Exhibitor appointments must be clean and neat. Appointments for the various sections follow.

- **Western** – Exhibitor must wear a western hat or protective headgear, western boots (**fashion heels are prohibited**), a long-sleeved shirt with a collar (including standup, tuxedo, oxford, button-down, turtle-neck and mock turtleneck) and long pants. If the pants have belt loops, a belt must be worn. A tie, pin, choker, necklace or scarf is required for open-collared shirts. Gloves are optional.

- **English Saddle Seat** – Exhibitors must wear jackets in conservative colors such as black, blue, grey or brown in showing and fitting. Riding habits for equitation classes will consist of a jacket with collars and lapels of the same conservative color with matching Kentucky jodhpurs (with pants straps to hold jodhpurs in place), a collared shirt, tie, vest and gloves. A derby of matching color or protective headgear may be worn. Boots should be jodhpur boots (without laces) of patent leather

or leather in complementary colors. Conservative colors for informal riding habits include black, blue, grey, burgundy, green, beige or brown, and may contain herringbone, pinstripes or other combinations of colors that appear solid. For exhibitors riding in the pleasure division, day coats may be worn. Derby may match Kentucky jodhpurs. Whips and unrowelled spurs are optional.

- **English Hunter Seat** – Entrants must wear hunt-style jackets or blazers in conservative colors (including but not limited to black, blue, hunter green, brown). Traditional hunt shirts in conservative colors are required. Conservative colors include but are not limited to white, ivory, pale pink, lavender, yellow, green, blue or subtle patterns. Riding breeches and hunt boots, or jodhpurs with garters or legging straps and jodhpur boots, are required. Recommended colors for breeches include tan, rust, grey or olive. ASTM/SEI-approved hunt caps are required when riders are mounted. Approved hunt caps are optional in showmanship; however, a hunt cap must be worn when exhibitor is wearing hunter seat attire. Regular ties or stock ties and stock pins are acceptable.

Fitting & Showing Criteria	Points
<b>Appearance of horse</b> .....	<b>40</b>
Condition & thriftiness (15)	
Grooming (20)	
Tack (5)	
<b>Showmanship</b> .....	<b>40</b>
Actions (10)	
Leading (15)	
Posing (15)	
<b>Exhibitor presentation</b> .....	<b>20</b>
Attitude (5)	
Appearance (5)	
Ring deportment (10)	
<b>Total</b> .....	<b>100</b>

## Criteria Explanation

### APPEARANCE OF HORSE (40 points)

#### Condition and thriftiness (15 points)

- Smooth, glossy coat and hard, rippling muscles
- Alertness and vigor
- Loose, pliable skin that is clean and healthy with fine, smooth, glossy hair



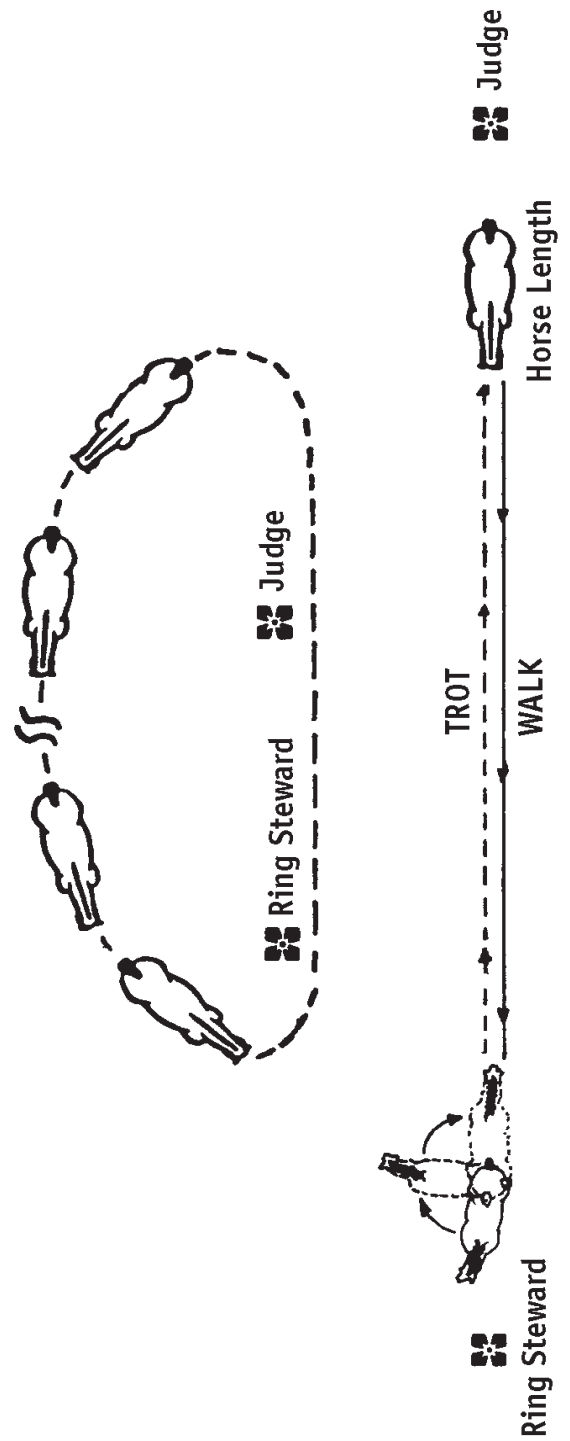
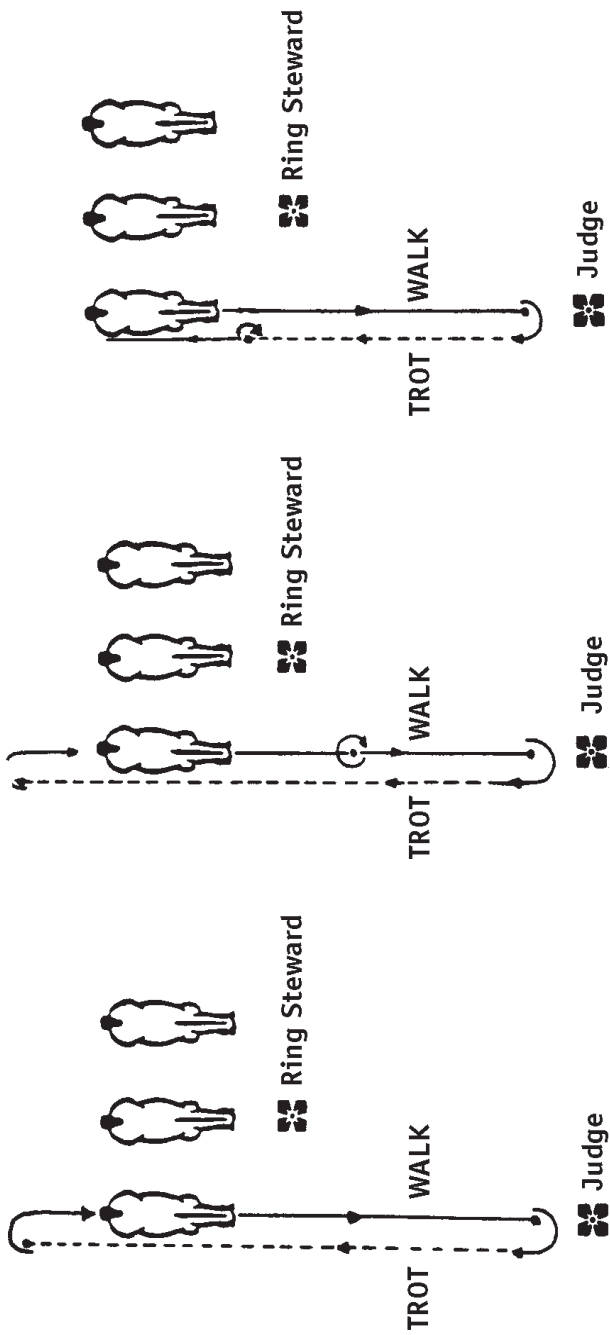

Figure 2. Sample fitting and showing patterns.

## FITTING & SHOWING DIVISION

- Evidence of correct balance of nutrition, care and exercise
- Excess fat or a thin, unthrifty condition is objectionable, and may be penalized at the judge's discretion.

### Grooming (20 points)

- Clean, well-brushed hair coat; dust, dandruff and stains are objectionable.
- Areas around the eyes, ears, muzzle, nostrils, between the legs, under the tail and the sheath (male animals only) must be clean.
- Mane and tail trimming and braiding should correspond to breed standards. The mane and tail must be clean and free of snarls, with the mane trained properly to fall on one side of the neck.
- Long hair should be trimmed from the fetlocks, bridle path, whiskers, throat latch and ears to correspond to breed standards. **Hair left inside the ears to protect against insects will not be penalized.**

### Tack (5 points)

- Must be clean, neat, supple and properly fitted.

### SHOWMANSHIP (40 points)

- Manners and actions in handling the horse reflect the time and effort spent in training. Actions of the horse indicate a willing response to the exhibitor.
- Exhibitor and horse should demonstrate the ability to work calmly and quietly in the class. Figure 2 illustrates patterns that might be used in a fitting and showing class.
- The exhibitor should lead from the left side of the horse, holding the lead shank in the right hand about 8 to 12 inches from the halter. Smaller exhibitors may need a longer hold. Emphasis should be placed on light control of the horse with minimum pressure on the lead shank to allow the horse to hold its head naturally. A loose, flopping lead strap is objectionable. Any excess strap length should be held loosely in the left hand in a figure eight coil or in a loose loop for safety.
- The horse should move readily and freely at a walk and/or trot (or second gait for gaited horses) with very little urging by the exhibitor. Those breeds that do not trot at halter should be shown according to breed standards. The exhibitor should stay in position by the near side of the horse's neck, preferably halfway between the horse's head and shoulder. A well-trained horse will move rapidly at a gait and speed equal to the speed at which the exhibitor is moving.
- The judge will designate an acceptable pattern for showing the horse's way of going. There are several points to remember when showing and moving a horse.

## FITTING & SHOWING DIVISION

- The horse should move out quickly and quietly when signaled to do so by the exhibitor.

- When moving toward or away from the judge or ring steward, the horse should be kept in a straight line.

- The exhibitor should move in a brisk, alert manner and allow enough slack in the lead rope for the horse's head to move freely. When walking behind another horse, the exhibitor should keep at least a horse length between himself or herself and the horse ahead.

- When stopping the horse in front of the judge or ring steward, the exhibitor should stop approximately a horse length away.

- The horse should set up quickly and stand squarely (or according to breed standards.)

- The exhibitor should stay to one side and not block the judge's view.

- When lining horses up, if there is not room to enter the existing line safely, exhibitors should start a new line (with help from the ring steward).

• Turns are usually made to the right. Small turns or pull turns (90 degrees or less) may be made to the left when common sense or safety applies, but collection and control of the horse are important. The horse must be under control and not free to swing its hindquarters. When a turn requires a pivot, the ideal turn should involve the horse pivoting on the right hind leg. The pivot foot should remain steady and the horse should not switch feet while turning. An exhibitor should not be penalized if the horse pivots on the left hind leg; however, more credit should be given to the exhibitor with the more correct pivot.

• **Draft Horses and Mules** – See the Draft Horse Division for information about showing draft horses and mules.)

• **Donkeys and Mules** – The exhibitor may use his or her hand on a donkey or mule's shoulder or nose to help position its feet when posing. Turns should be a pivot on the haunches. Exhibitors should hold the lead shank in the right hand about 6 to 12 inches from the halter. A donkey exhibitor may carry a crop and have a trailer to assist at the trot.

• **Exhibitor Position** – When the horse is in the posed position (see fig. 3) and the judge walks past or around the horse, the exhibitor should be in areas A or B. A and B are to the side, but ahead of the horse. This position allows the most ease of moving from side to side with as little motion as possible. The area around the horse is divided into four quadrants as shown. The handler should be in the quadrant adjacent to the quadrant the judge is occupying, as follows:

Judge's Position	Exhibitor's Position
Quad 1	B
Quad 2	A
Quad 3	B
Quad 4	A

• Note the “safe zones” designated in figure 4. These are the safe areas where the exhibitor is out of the direct line of a sudden lunge, a strike from the front legs or a kick from the back legs. In halter and fitting and showing classes the exhibitor can move to either side of the horse. This is safe if the horse is properly trained before entering the show ring. A horse acts independently on each side; therefore, it must be trained to lead, stand and show from each side. The shaded areas in the figure indicate the safe areas for showing a horse from either side. Note the danger zone directly in front of the horse. Learn to stand toward the front, not in the danger zone, but out of the direct line of action of a strike or a lunge. The exhibitor can cross the danger zone to get from one side of the horse to the other. Remaining in the danger zone is a fault.

• When it is necessary to let the judge inspect the horse’s near side, step into the safe zone on the offside as shown in figure 4. An exhibitor should not remain in the danger zone longer than the moment it takes

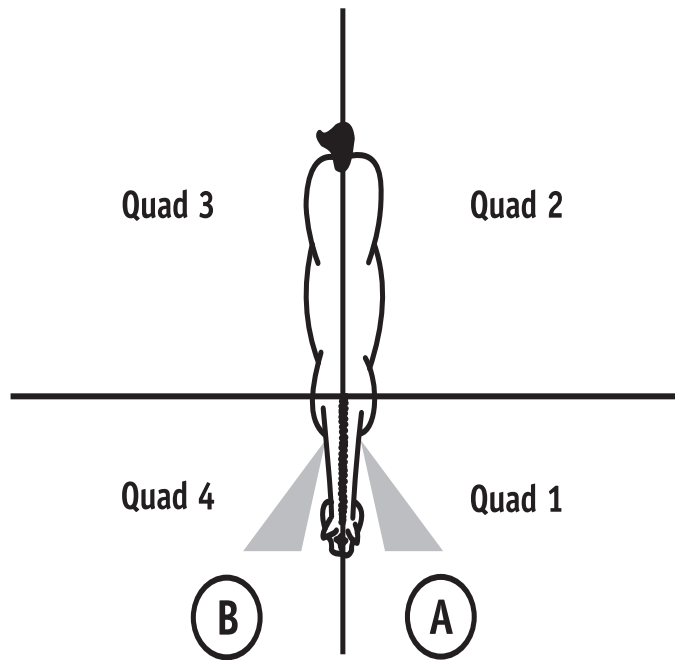

Figure 3. The quarter system of judging fitting and showing.

to cross in front of the horse. A good exhibitor will try to use positions within the safe zones where he or she can watch both the horse and the judge.

• The exhibitor can pass between the judge and the horse as the judge moves around the animal, but the exhibitor should avoid blocking the judge’s view longer than the moment required to step between the horse and the judge. The exhibitor should step quickly and quietly.

**EXHIBITOR PRESENTATION (20 points)**

- Businesslike and friendly.
- Cooperates with the judge, ring steward and other exhibitors.
- Concentrates on showing the horse and is not distracted by people and events outside the ring.
- Courteous, attentive and maintains a sportsmanlike attitude toward officials and other exhibitors.
- Portrays confidence in the horse’s training and in their own ability to present the animal.

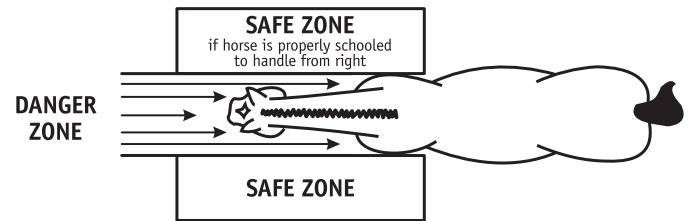

Figure 4. Danger and safety zones for handling horses.

# Halter Division

**APPOINTMENTS OF HORSE** – Tack must be clean, neat, supple and properly fitted. Appointments of the horse for the various divisions follow.

- **Western** – Horse must be shown in halter. The use of a chain end lead shank with the chain under the horse’s jaw or over the horse’s nose is permitted for safety reasons.
- **English (saddle-seat type)** – Horse may be shown in a bridle if over age 2. The snaffle rein should be removed or secured to the mane at the withers. Whips or crops may be used with discretion. Exception: Arabians may be shown in a pleasure type or fine horse show halter at any age.
- **English (hunter-seat type)** – Horse may be shown in a bridle (such as a snaffle, kimberwick or pelham) if over age 2. A plain leather halter with throat latch is also acceptable.
- **Draft** – Horse should be shown in a white rope halter or flat white nylon or leather halter with matching lead strap. Show sticks are optional, but abusive use of show sticks will be penalized.

**APPOINTMENTS OF EXHIBITOR** – Exhibitor appointments must be clean and neat. Appointments for the various sections follow.

- **Western** – Exhibitor must wear a western hat or protective headgear, western boots (**fashion heels are prohibited**), a long-sleeved shirt with a collar (including band, standup, tuxedo, oxford, button-down or turtleneck) and long pants. If the pants have belt loops, a belt must be worn. One-piece equitation suits are permissible. A tie, pin, choker or scarf is required. Gloves are optional.
- **English Saddle Seat** – Exhibitors must wear jackets in conservative colors such as black, blue, grey or brown. Pleasure class exhibitors may wear day coats. Clothing must include Kentucky jodhpurs that match or coordinate with the jacket; a collared shirt; a tie; a derby, soft hat or protective headgear; and jodhpur boots. Whips, gloves and small boutonnieres are optional. Formal evening wear is inappropriate for daytime 4-H shows.
- **English Hunter Seat** – Exhibitors must wear hunt-style jackets or blazers in conservative colors (including but not limited to blue, black, hunter green or brown). Traditional hunt shirts in conservative colors are required. Riding breeches and hunt boots, or jodhpurs with garters or legging straps and jodhpur boots are required. Recommended colors for jodhpurs include tan, rust, grey or olive. Protective headgear is required (see General Rule 3). Regular ties or stock ties and stock pins are acceptable.

Halter Criteria	Points
<b>Conformation</b> .....	<b>80</b>
<b>General appearance:</b> Breed type & fitness (10)	
<b>Form:</b> Balance, correctness & appropriateness of muscle through body, shoulders, chest, arm & forearm, back, loin, croup, hindquarters, gaskin, withers (25)	
<b>Head and neck:</b> Style, breed character, clean-cut appearance (15)	
<b>Feet and legs</b> (including feet, legs, pasterns, canons, knees, hocks): Straightness, correctness, substance (20)	
<b>Quality:</b> Bone, tendons & joints (10)	
<b>Movement</b> .....	<b>20</b>
Correctness & breed character shown at the walk & trot (20)	
<b>Total</b> .....	<b>100</b>

## Evaluation & Criteria Explanation

Judges should be aware of current breed standards for horses showing at halter and conduct classes accordingly.

- Entries are to be judged on conformation, breed type, quality and way of going.
- A judge may eliminate or severely mark down a horse showing in a specific halter section (for example, pleasure type) where, in the opinion of the judge, the animal is not a correct representative of that conformation type.
- Blemishes – such as scars, splints and spavins – are to be marked down according to their effect on soundness. Transmissible weakness and unsoundness are to be counted strongly against the horse.
- Horses are to be shown in hand at a walk and second gait.
- For safety reasons, a judge may penalize or disqualify an exhibitor for intentionally dropping the lead during a halter class.

In breed classes, horses may be shown with two handlers where breed custom dictates. In mixed breed classes, horses are allowed only one handler.

## Longe Line Division

Only yearling and 2-year-old animals are eligible for this division. Horses shown in this division cannot be shown in any under-saddle classes.

**Appointments of Horse** – Horses should be shown in show or work-type halters. A longe line with or without a chain must be snapped to the halter. If a chain is used, the chain should not be run under the chin, over the nose or over the poll – only snapped to halter. Longe whips are allowed, and if used, cannot touch the animal. Splint boots are optional; however, wraps or bandages of any kind are not allowed.

**Appointments of Exhibitor** – Western appointments as described in the Fitting and Showing Division are required, unless the horse is presented as a hunter, in which case the animal's mane and tail should be braided and the handler must wear hunt attire.

### Criteria

**HORSE'S PERFORMANCE AND MANNERS** – Movement of the horse should be judged as pleasurable and natural. Emphasis should be placed on how well the horse moves and on its attitude, as reflected in its ears, mouth, tail and way of going. Minor breaks of gait and momentary lapses of attention or playing on the part of the horse should not be penalized. However, the horse should be in control at all times. The judge may penalize a horse for excessive bucking, running off, or willful disobedience. Conformation will be considered but will not count more than 20 points.

**EXHIBITOR** – The exhibitor's manners and actions in handling the horse on the line reflect the time and effort the exhibitor has spent training the horse. The actions of the horse should indicate a willing response to the exhibitor. The exhibitor and horse should demonstrate the ability to work calmly and quietly.

**PENALTIES** – Per infraction each direction.

-5 Failure to demonstrate the correct lead, jog/trot and walk for an adequate distance to allow for proper evaluation.

**DISQUALIFICATIONS** – Disqualifications include:

- Evidence of lameness
- Fall to the ground by horse (a horse is deemed to have fallen when its shoulder or hip or underline touches the ground)
- Improper equipment
- Evidence of abuse, including but not limited to broken skin, rawness or bleeding on the horse's chin, muzzle or nose
- Exhibitor disrespect to judge
- Blatant striking of horse with longe whip to cause forward or lateral movement

- Horse stepping over or becoming entangled in longe line.
- Failure to show at all three gaits in both directions
- Horse becoming loose in the arena

All rules apply when judge is present in arena until all judging is complete.

### Class Procedure

1. Exhibitors will enter the ring with their horses one at time.
2. Exhibitors will work their horses for 90 seconds – 45 seconds in each direction. (A timer should blow a whistle to notify the exhibitors to begin, at 45 seconds and at 90 seconds.) The exhibitor may start the horse working in either direction of the ring. A horse being shown in hunter seat tack must walk, trot or canter in both directions of the ring. A horse being shown in western tack must walk, jog and lope in both directions of the ring. The exhibitor may determine how much time is spent at each gait. For example, if a horse is an exceptional jogger, the exhibitor may choose to showcase that ability after completing all of the required gaits.
3. The longe line cannot touch the animal.
4. After all of the exhibitors have longed their horses, they are to lead their horses into the ring, line up in a row, set up as in a halter class and be judged. Exhibitors may choose to use a lead shank during this part of the class. The lead chain may be placed under the horse's chin or over its nose, as in a halter class.
5. Each exhibitor may show only one horse in each longe line class. The same exhibitor must show in both the longe and halter portions of the class.

### Scoresheets

Suggested scoresheets are available online at [nsba.com](http://nsba.com). Click on "Judges Information," then "Score Sheets," then "Longe Line."

# English Riding Division

## ENGLISH APPOINTMENTS

**APPOINTMENTS OF HORSE (ENGLISH SADDLE SEAT)** – A flat English-type saddle is required. The girth may be patent leather or leather. Unconventional saddles combining characteristics of English and western styles, and forward seat saddles are prohibited.

A full bridle consisting of a snaffle bradoon and a curb bit with a shank length that measures no more than 7.25 inches and a curb strap that approximately two fingers can be inserted between it and the horse’s chin, is preferable. Pelhams are also acceptable. Two reins are required, one of which may be laced or braided. Tennessee walking horses may be shown in a walking horse bit with a single rein. No bit converters, single snaffles, hackamores, kimberwicks, martingales or tie downs are allowed.

No braiding of forelocks, manes or tails – with the exception of saddle-type horses or ponies with show ribbons – is permitted in saddle seat classes.

**APPOINTMENTS OF RIDER (ENGLISH SADDLE SEAT)** – Basic appointments of riders for this section are the same as for the Fitting and Showing: English Saddle Seat section.

**APPOINTMENTS OF HORSE (ENGLISH HUNTER SEAT)** – Wraps or protective boots are allowed only in classes over fences. A hunting saddle of the English forward seat type is required. Unconventional saddles combining characteristics of English and western styles are prohibited.

Regulation snaffles, pelhams, kimberwicks and full bridles, all with leather browbands and cavesson nosebands, are required. **Note:** U-shaped bit converters may be used with a bit designed for two reins to allow for control with a single rein.

Martingales are prohibited in all classes on the flat but are permitted in classes over fences. Stirrup pads are suggested. Split reins are not permitted. Unconventional and wire bits and nosebands may be penalized at the judge’s discretion.

**APPOINTMENTS OF RIDER (ENGLISH HUNTER SEAT)** – Basic appointments of riders for this section are the same as for the Fitting and Showing: English Hunter Seat section. Protective headgear is required (see General Rule 3). Spurs without rowels, crop, bat and gloves are optional. Gloves are preferred for equitation.

**APPOINTMENTS OF HORSE AND RIDER (GAITED HORSES)** – Horses and riders should be outfitted in accordance with the rules of their breed; however, no artificial devices to enhance a horse’s gait, other than standard horse shoes, are permitted.

# ENGLISH CLASSES

## Open English Pleasure

Open English Pleasure Criteria	Points
Horse’s performance .....	90
Appointments of horse & rider .....	10
<b>Total .....</b>	<b>100</b>

### Criteria Explanation

**HORSE’S PERFORMANCE** – Riders shall enter the ring in a counter-clockwise direction. All horses shall be worked both ways of the ring at a walk, trot (or second gait) and canter (or third gait). Extended gaits may be called for at the discretion of the judge. Horses must stand quietly and back readily in the line. Extreme speed will be penalized. Manners and suitability as a pleasure mount are paramount. Transition from one gait to another should be smooth and effortless. Horses must be obedient with prompt transitions. All seats will be given equal consideration.

**APPOINTMENTS OF HORSE AND RIDER** – See the “English Appointments” section in this division.

## ENGLISH SADDLE SEAT

### Saddle Seat Equitation

Saddle Seat Equitation Criteria	Points
Rider’s position & appointments of horse & rider .....	90
Horse’s performance & suitability .....	10
<b>Total .....</b>	<b>100</b>

### Criteria Explanation

**RIDER’S POSITION** – Riders should establish and maintain a seat that is thoroughly efficient and comfortable for riding the type of horse called for, at any gait and for any length of time. The method of holding the reins should be consistent with the type of equipment being used. Both hands should be used and both reins must be picked up at one time. The bight of the reins should be on the off side; the hands should be in line with the bit and the elbows. The feet should rest with the balls of the feet on the stirrups and the heels down. No swaying of the legs should be visible.

To obtain the proper position, the rider should place himself or herself comfortably in the saddle and find his or her center of gravity by sitting with a slight bend at the knees without the use of the stirrups. While

in this position, the rider should adjust the leathers to fit. Each stirrup iron should be placed under the ball of the foot (not under the toe or “home”), with even pressure on the entire width of the sole and the center of the iron. The feet should be positioned with the toes forward, neither in nor out, and heels should be down. A vertical line drawn from the rider’s shoulders downward should pass through the shoulders, hips and heels. The upper calves of the rider’s legs should have contact with the horse (see fig. 5).

With gaited horses, the rider’s legs will be forward at the knee and may give the impression of a slightly reclined position to the upper torso.

When the horse is moving, the rider’s position should change in the following manner:

- **Walk** – Slight motion in the saddle.
- **Trot or second gait** – Slight elevation in the saddle; hips under the body, not swinging forward and backward or moving up and down mechanically. Posting by breed standard.
- **Canter or third gait** – Close seat going with the horse.

**APPOINTMENTS OF HORSE AND RIDER** – See “English Appointments” section in this division.

**HORSE’S PERFORMANCE AND SUITABILITY** – Riders enter the ring counterclockwise. All riders will be worked both ways of the ring at all required gaits showing the walk, trot (or second gait) and canter (or third gait). Reversing may be either toward or away from the rail. Riders may be asked to perform individual workouts. A complete picture of the whole is of major importance. Riders should convey the

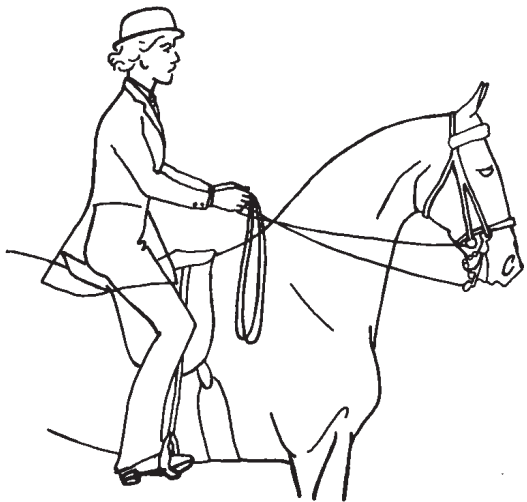

**Figure 5. Correct hands & seat for saddle seat equitation.**

impression of effective and easy control. All seats should be given equal consideration.

## General Guidelines

Judges should note that the required equitation seat should in no way be exaggerated, but should be the most efficient and comfortable seat for riding the type of horse called for, at any gait and for any length of time. In saddle seat equitation classes, the riders should convey the impression of effective and easy control.

**Mounting and dismounting** – To mount, the exhibitor should take up the reins in the left hand and place that hand on the withers. The exhibitor should then grasp the stirrup leather with the right hand, insert the left foot in the stirrup and mount. To dismount, the rider may either step down or slide down. The rider’s size should be considered.

**Hands** – The hands should be held in an easy position, neither perpendicular nor horizontal to the saddle, and should show sympathy, adaptability and control. The height at which the hands are held above the horse’s withers depends on how and where the horse carries its head. However, the reins and the rider’s forearm should form a straight line from the horse’s mouth to the rider’s elbow. The method of holding the reins is optional; however, it is necessary that both hands be used and all reins must be picked up at one time. The bight of the reins should be on the off side.

Judges should note that the required equitation seat should in no way be exaggerated, but should be the most efficient and comfortable seat for riding the type of horse called for, at any gait and for any length of time. In saddle seat equitation classes, the riders should convey the impression of effective and easy control, while displaying confidence.

## Individual Tests

These tests may be performed individually or as a group.

1. Address the reins.
2. Back.
3. Individual performance on the rail.
4. Figure eight at the trot (or second gait), with a correct change of diagonals. At the left diagonal, the rider should be sitting the saddle when the horse’s left front foot is on the ground. At the right diagonal, the rider should be sitting the saddle when the horse’s right front foot is on the ground. When circling clockwise, the rider should be on the left diagonal. When circling counterclockwise, the rider should be on the right diagonal.
5. Figure eight at the canter with a change of lead through the walk (figures should begin in the center of the two circles so that one lead change is shown).

6. Change leads down the center of the ring or on the rail, with a change of leads through the walk.

7. Ride without stirrups (no more than 2 minutes at the trot). The class must be halted before starting this test. The riders will pick up the irons and cross them in front of the pommel for safety before the class is continued. At the end of the test the class must be halted so the riders can regain their irons. Judges should consider ages and skill levels of riders when using this test.

8. Answer the judge's questions. It is recommended that the same questions be asked of each rider privately. An example would be one question each about tack, anatomy and equitation.

9. Serpentine at the trot or canter demonstrating the correct diagonal or lead changes.

## Saddle Seat Pleasure

Saddle Seat Pleasure Criteria	Points
Horse's performance & manners.....	90
Appointments of horse & rider.....	10
<b>Total.....</b>	<b>100</b>

### Criteria Explanation

**HORSE'S PERFORMANCE AND MANNERS** – The horse should be shown at the walk, trot (or second gait), strong or extended trot (not park trot), and canter both ways of the ring. The horse must stand quietly and back readily. Excessive speed at the strong or extended trot will be penalized. Horses are judged on manners, quality, performance and suitability of horse to rider.

**APPOINTMENTS OF HORSE AND RIDER** – See the "English Appointments" section in this division.

## Gaited Pleasure

### Judging

The purpose of the Gaited Pleasure class is to recognize correct gaiting for the breed being shown, smoothness in the horse's gait, the horse's responsiveness to its rider and harmony between the horse and rider. The horse and rider must work as a team. The rider should sit quietly in the saddle with little hand and leg movement. The horse should be quick to respond to changes and never break gait until another gait is called.

Failure to demonstrate a recognizable difference between the second and third gaits will be penalized. Some horses (such as the Peruvian paso and racking horses) may have the same movement

in both gaits, but display a noticeable difference in speed. The judge may ask an exhibitor to demonstrate his or her horse's three gaits if the judge has seen no noticeable difference. No artificial devices are permitted to enhance a horse's gait, other than standard horse shoes.

Gaited Pleasure Criteria	Points
Horse's performance, manner & gaits.....	90
Appointments of horse & rider.....	10
<b>Total.....</b>	<b>100</b>

### Criteria Explanation

**HORSE'S PERFORMANCE AND MANNERS** – The horse is to be shown in the following order both ways of the ring: walk, second gait, walk and third gait. The horse must stand quietly and back readily. The horse is to be judged as a pleasant riding horse with true road and trail qualities. Manners, performance, substance and conformation will be considered. The horse should be shown with a light rein at all gaits. "Bumping" and "pumping" of the reins will be penalized.

**HORSE'S GAITS** – The descriptions that follow apply to the gaits required in gaited pleasure horse classes. Many gaited horses bob or nod their heads with the rhythm of their second and third gaits, so that movement is not a clue to soreness or lameness the way it is in nongaited horses. Stiff legged front or rear motion and twisting the hocks (especially when entering the ring) are typical of the movement of a sore or lame horse, and the judge should immediately excuse any horse exhibiting this type of motion from the ring.

**Walk** – True, square and flat with a head motion conforming to breed standards.

**Second Gait** – Tennessee walking horses should display a smooth, gliding overstepping four-cornered gait, with the horse having stride and head nod. Their second gait (the running walk) should be free and easy. Horses exhibiting an exaggerated, hesitating way of going with a tendency to point or strike the ground heel first with the front feet are not in form.

Racking horses should display a smooth lateral (same side) action gait with the hind foot leaving the ground first to create a true four-beat, single-foot gait with only one foot off the ground while in the rack. The hind foot should overstep and should give a full reaching stride. Slight vertical head action is desired in the show walk. The horse should appear to be performing a broken pace when walking the stride from back legs to front legs (laterally) or the horse will appear to be performing a broken trot when the stride is viewed from the front to the back (diagonally). Some horses may pace, which can be detected by their side-to-side head motion. A pace is preferred over a



trot. A high hock action is not characteristic of a true racker, and will, therefore, be penalized.

**Third Gait** – Tennessee walking horses should display the canter, smooth and straight on both leads, not walking behind but cantering on both ends with a rolling motion, comfortably in hand. Exaggerated pumping of the horse at the canter is not good form.

Rackers should display the same cadence as in the second gait, but the horse should increase its speed. The horse and rider should still not show any sign of strain at the increased speed. A gaited horse that is moving at excessive speed is apt to lose its gait and will be penalized. At no time should form be sacrificed for speed. Since this gait will not be picked up immediately from the walk, the smoothness and ease of the increase should be judged.

**APPOINTMENTS OF HORSE AND RIDER** – See the “English Appointments” section in this division.

**ENGLISH HUNTER SEAT CLASSES**

**Gaits**

The following descriptions of gaits apply in all English hunter seat classes:

1. The **walk** should be a true four-beat forward working gait, rhythmic and flat footed. An extremely slow or excessively quick or jiggy walk will be penalized.
2. The **trot** is a two-beat diagonal gait, and should be long, low and ground covering with cadenced and balanced strides. Correctness is more essential than speed. Extreme speed or a jog trot will be penalized.
3. The **canter** must be a smooth, free moving, relaxed, three-beat gait that is straight on both leads. The stride should be ground covering. An over-collected or four-beat gait will be penalized. Excessive speed will be penalized.
4. The **hand gallop** is performed with long, free, ground covering strides, with the horse under control. The amount of ground covered may vary between horses due to natural differences in their stride length. The hand gallop is not a fast canter, but a true lengthening of stride, correct and straight on both leads. Extreme speed or lack of control will be penalized.

**Hunter Seat Equitation on the Flat**

Hunter Seat Equitation on the Flat Criteria	Points
Rider's position (seat, hand, use of aids) .....	90
Horse's performance, appointments & suitability of horse & rider...	10
<b>Total .....</b>	<b>100</b>

**Criteria Explanation**

**RIDER'S POSITION** – The method of holding the reins should be consistent with the type of equipment being used; however, all reins must be picked up at the same time. The rider should keep the ankles flexed in, the heels down and the calves of the legs in contact with the horse and slightly behind the girth (see fig. 6).

**HORSE'S PERFORMANCE** – Riders will be instructed to have their horses walk, trot and canter both ways around the ring. The order to reverse may be executed either toward or away from the rail. Light contact with the horse's mouth is required. Riders may be asked to perform any appropriate tests.

**APPOINTMENTS OF HORSE AND RIDER** – See the “English Appointments” section in this division.

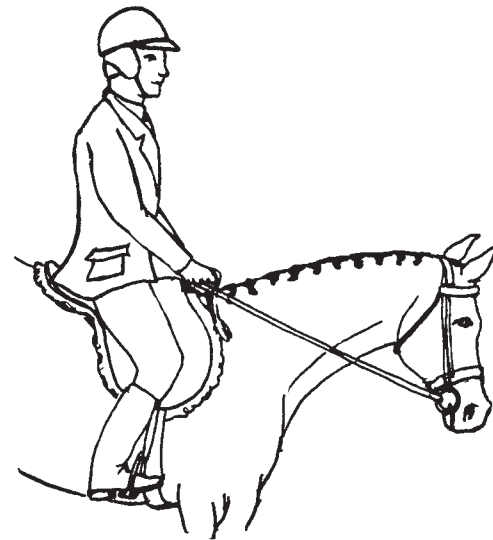

Figure 6. Correct hands and seat for hunter seat equitation.

## General Guidelines

The rider should have a workmanlike appearance, and light and supple seat and hands, conveying the impression of complete control should any emergency arise.

**Mounting and Dismounting** – To mount, the exhibitor should take the reins in the left hand and place that hand on the withers. The exhibitor should grasp the stirrup leather with the right hand, insert the left foot in the stirrup, and mount. To dismount, the rider may either step down or slide down. The size of the rider must be taken into consideration. The rider is permitted to lengthen the stirrup to mount.

**Hands** – The hands should be over and in front of the withers, with the knuckles 30 degrees inside the vertical and the hands slightly apart and making a straight line from the horse's mouth to the rider's elbow. The method of holding the reins is optional; however, all reins must be picked up at the same time. The bight of the reins may fall on either side. Direct contact should be maintained at all times.

**Basic Position** – The rider should have eyes up and shoulders back. The toes should be out at an angle best suited to the rider's conformation. The rider should have the ankles flexed in, heels down and the calves of the legs in contact with the horse and slightly behind the girth. The iron must be on the ball of the foot.

**Rider's Position in Motion** – At the walk and sitting trot, the rider's body should be slightly ahead of the vertical. At the posting trot, the rider's body should be inclined slightly forward, but not exaggerated. At the canter, it should be halfway between the posting trot and the walk positions. When galloping, riders should use the same inclination as at the posting trot.

## Individual Tests

These tests may be performed individually or in a group.

1. Address the reins.
2. Back.
3. Individual performance on the rail.
4. Figure eight at the trot (or second gait), with a correct change of diagonals. At the left diagonal, the rider should be sitting the saddle when the horse's left front foot is on the ground. At the right diagonal, the rider should be sitting the saddle when the horse's right front foot is on the ground. When circling clockwise at a trot, the rider should be on the left diagonal; when circling counterclockwise, the rider should be on the right diagonal.
5. Figure eight at the canter with a simple change of lead. Figures should begin in the center of the two circles so that one lead change is shown.

6. Change leads down the center of the ring or on the rail, with a change of leads through the walk.

7. Ride without stirrups (no more than 2 minutes at the trot). The class must be halted before starting this test. The riders will pick up their irons and cross them in front of the pommel for safety before the class is continued. At the end of the test the class must be halted so that riders can regain their irons. Then the class will resume.

8. Answer the judge's questions. It is recommended that the same question be asked of each rider privately. An example would be one question each about tack, anatomy and equitation.

9. Serpentine at the trot or canter demonstrating the correct diagonal or lead changes.

## Hunter Seat Equitation Over Fences

### General Rules

1. Exhibitors will be allowed to walk the course.
2. If a warm-up fence is not provided outside the show arena, exhibitors will be allowed one practice jump designated by the show committee.
3. The course should include at least six jumps, each a minimum of 10 feet wide and not to exceed 3 feet tall, with wings at least 30 inches wide. Ground poles on the take-off side of the jump are required. When jumps are approached from both sides, ground poles are required on both sides.
4. The fall of a horse or rider will eliminate a contender. If such a fall (or three disobediences) occurs during a rideoff, the contestant will be placed last of all those chosen for the rideoff.
5. Any rider not having his or her mount under control must be dismissed from the ring and disqualified from the class.
6. Class courses should be posted near the in-gate well before the class begins.
7. Horses must be serviceably sound.
8. Judges will penalize unsafe jumping and bad form over fences, whether an obstacle was touched or not.
9. Judges should review the course and make any necessary alterations before the first horse and rider enter the course.

Before placing a class, the judge must call the horses back in the order of performance merit to consider soundness. The horse must be led into the ring at a trot or second gait, with the reins in hand and the stirrups run up. Two horses more than the number of ribbons available

should be called in. Horses are to be evaluated for soundness as they come into the ring and line up.

**Hunter Seat Equitation Over Fences**

Criteria	Points
Rider's position (seat, hands & use of aids): Over & between fences, appointments, & suitability of horse & rider .....	90
Horse's performance .....	10
<b>Total .....</b>	<b>100</b>

**Criteria Explanation**

**RIDER'S POSITION BETWEEN FENCES** – See "Hunter Seat Equitation on the Flat."

**RIDER'S POSITION IN THE AIR** – The rider should exhibit weight in the heel, and the rider's calf should be in contact with the horse's sides behind the girth supporting the upper body of the rider. The seat should be next to but out of the saddle, and the upper body should follow the horse's arc. Eyes should be up, shoulders back, the back should be flat, and arms and hands should ensure freedom of the horse's head and neck. Crest release or correct automatic release is equally acceptable.

**HORSE'S PERFORMANCE** – The performance begins when the horse enters the ring or when the rider is given the signal to proceed after entering the ring. Except for refusals, jumping faults of the horse are not to be considered unless they are the result of the rider's ability. Each contestant may circle once if desired before approaching the first jump. He or she will then proceed around the course, keeping an even pace throughout. Three cumulative refusals will result in the contestant's elimination. Following the third refusal on the course, the rider must leave the arena. If a refusal occurs in a double or triple jump, the rider must rejump all elements of the combination. Any or all contestants may be called back to perform at a walk, trot (or second gait) or canter (or third gait), or to execute any appropriate tests included in the class requirements.

**Individual Tests**

These tests are to be performed individually.

1. Jump low fences at a walk or trot (or second gait), as well as at a canter (or third gait).
2. Jump fences on a figure eight course.
3. Jump fences in the middle of the ring at right angles to the course.
4. Any of tests 1 through 9 in the "Hunter Seat Equitation on the Flat" section.

**Hunter Under Saddle  
(Hunter Seat Pleasure)**

Hunter Under Saddle Criteria	Points
Horse's performance & manners.....	90
Appointments of horse & rider.....	10
<b>Total .....</b>	<b>100</b>

**Criteria Explanation**

**HORSE'S PERFORMANCE AND MANNERS** – Horses are to be shown at the walk, trot and canter both ways of the ring. Light contact with the horse's mouth is required. Horses are to be judged strictly on performance and soundness. They should move freely, exhibiting the gaits as described in "Gaits" in the "English Hunter Seat Classes" section. Any horse showing evidence of lameness will be refused an award. If horses are hand galloped, there should be no more than eight performing at one time. Manners are to be emphasized.

**APPOINTMENTS OF HORSE AND RIDER** – See the "English Appointments" section of this division.

**Working Hunter Over Fences**

Working Hunter Over Fences Criteria	Points
Horse's performance .....	90
Appointments of horse & rider.....	10
<b>Total .....</b>	<b>100</b>

**Criteria Explanation**

**HORSE'S PERFORMANCE** – Horses should have an even hunting pace, good manners, a safe style of jumping, a correct way of moving over the course and a correct way of moving when being judged for soundness. Extreme speed will be penalized. Correct leads in corners are preferred. Breaking gait (canter or trot) except to correct an incorrect lead or cross-fire, will be penalized.

**APPOINTMENTS OF HORSE AND RIDER** – See the "English Appointments" section of this division.

**Hunter Course**

Judges are responsible for the correctness of each course after it has been set, and should call the show committee's attention to any errors that would result in unfair or inappropriate courses. Exhibitors will be allowed to walk the course after the judge has approved the course.

## Course or Arena Arrangement

1. Arrangements should include a minimum of four obstacles. Horses are to make a minimum of eight jumps, and at least one change of direction is required.

2. The following types of obstacles may be used: Fences that simulate obstacles found in the hunting field, such as post and rail, brush, stone wall, white fence or gate, chicken coop, Aiken or hedge.

3. The following jump types are prohibited: A pole over brush, triple bars, hog backs, hinged chicken coops and square oxers.

4. The top elements of all fences must be securely placed so that a slight rub will not cause a knockdown, but so that the elements will fall if hit hard.

5. Obstacle characteristics include:

- Single obstacles should be located at 12- to 18-foot intervals. There should be a minimum of 48 feet between obstacles.
- The height of obstacles must not exceed 3 feet.
- The use of wings on obstacles in hunter classes is recommended. Ground poles placed on the take-off side of jumps are required. When jumps are approached from both sides, ground poles are required on both sides.
- Unused jump cups and pins must be removed from jump standards.

6. A combination jump is recommended in all hunter courses. The recommended distance for combination jumps is:

- One stride in-and-out 22 feet to 26 feet
- Two stride in-and-out 36 feet
- Three stride in-and-out 48 feet

Fences must be at least 10 feet wide, though wider fences are desirable, and wings of at least 30 inches are recommended.

## Scoring Hunter Classes

Horses should be sound and have an even hunting pace, good manners and a safe style of jumping, together with a smooth way of moving over the course. Extreme speed will be penalized. Circling once when entering the ring and once when leaving is required.

**Faults** – Following are guidelines to use when scoring faults:

- When a horse makes two faults at one obstacle, only the major fault will be counted, except for refusals, which will count in addition to other major faults.
- When an obstacle includes two or more fences (such as an in-and-out), the faults committed at each element are considered separately. In cases of a refusal or runout at one element, the contestant must rejump all elements of the combination.

• When an obstacle is composed of several elements in the same vertical plane, a fault at the top element is the only one penalized.

• Judges will penalize unsafe jumping and bad form over fences whether the obstacle was touched or untouched.

• Light touches are not a major consideration, but they may be scored according to the following scale in cases where elimination is difficult.

- Touching with any part of the horse's body behind the stifle (½ fault)

- Touching with any part of the horse's body in front of the stifle (1 fault)

- Touching a standard or wing while jumping an obstacle with any part of the horse, rider or equipment (1 fault)

**Knockdowns** – An obstacle is considered knocked down when its height is lowered by horse or rider:

- With any part of the horse's body behind the stifle (4 faults)
- With any part of the horse's body in front of the stifle (8 faults)
- Lowering a standard or wing in jumping an obstacle with any part of the horse, rider or equipment (8 faults)

If an obstacle is used for more than one jump and is knocked down on the first jump, the rider may pull up or circle until the judge signals that the jump is reset.

**Disobediences** – Disobediences are major faults that will be heavily penalized. These include the first and second refusal, runout, bolting on course or an extra circle on entering or leaving course (8 faults).

**Elimination** – The following are causes for elimination:

- Third refusal, third runout, third time bolting on course
- Jumping an obstacle before it is reset
- Bolting from the ring
- Failing to stay on course
- Jumping an obstacle not included in the course
- Fall of the horse or rider

**Ponies** – The same rules listed for scoring hunter classes apply to scoring hunter classes for ponies. However, for ponies not exceeding 52 inches, fences should not exceed 2 feet and in-and-outs should not exceed a distance of 20 feet. For ponies over 52 inches but not exceeding 56 inches, fences should not exceed 2½ feet and in-and-outs should not exceed a distance of 22 feet.

## Baby Green Over Fences

The Baby Green Over Fences class is suggested for horses or riders in their first year of 4-H over fences classes. A horse and rider exhibiting in this section may not show in any other classes over fences.

Baby Green Over Fences Criteria	Points
Horse's performance .....	90
Appointments of horse & rider .....	10
<b>Total .....</b>	<b>100</b>

### Criteria Explanation

**HORSE'S PERFORMANCE** – See the information on the horse's performance in the "Working Hunter Over Fences" section in this division.

**APPOINTMENTS OF HORSE AND RIDER** – See the "English Appointments" section in this division.

### Course Arrangements

Minimum of four fences, all cross rails to be 12 to 18 inches high with ground poles. Courses must be arranged in a side, diagonal, side pattern. Horse in this section may not show in any other classes over fences.

## Hunter Hack

Hunter Hack Criteria	Points
Performance & manners in rail work .....	45
Performance, way of going & manners on individual work.....	45
Appointments of horse & rider .....	10
<b>Total .....</b>	<b>100</b>

### Criteria Explanation

**PERFORMANCE AND MANNERS IN RAIL WORK** – See "Hunter Under Saddle" in this division.

**PERFORMANCE, WAY OF GOING AND MANNERS ON INDIVIDUAL WORK** – See "Working Hunter Over Fences" in this division.

**APPOINTMENTS OF HORSE AND RIDER** – See the "English Appointments" section in this division.

### Class Conditions and Rules

#### Individual Work:

All horses competing will first be lined up at one side of the arena for instructions from the judge for individual work. The individual work shall consist of no less than the following:

- Separate from the lineup, canter and proceed to jump two fences. These fences must be brush or simple post and rails, with ground poles in front of each fence. If a brush jump is used, it must be the first fence jumped. Jumps do not have to be set on a line. However, if jumps are set on a line, they must be 36 feet, 48 feet or 60 feet apart. The height of the fences must not be higher than 2 feet 6 inches.

- Hand gallop
- Stop and settle at a point at least halfway down the long side of the arena.
- Back and stand quietly.
- Return to lineup.

Faults over fences will be scored as in working hunter classes.

#### Rail Work:

The hunter hack must be shown at a walk, trot and canter both ways of the ring. It is the judge's option to require an exhibitor to extend any gait and to back easily. Emphasis shall be placed on actual suitability to purpose. Light contact with horse's mouth is required. Horses should be obedient, alert, responsive and move freely. They should not be eliminated for slight errors.

- **Walk** – True and flat-footed for pleasure classes.
- **Trot** – Brisk, smart, cadenced and balanced without loss of form. An extended trot may be called for at the judge's option.
- **Canter** – Smooth, three-beat, collected and straight on both leads, with the ability to push on, if required, into a hand gallop.

## Bareback English Equitation

Bareback English Equitation Criteria	Points
Rider's position & appointments of horse & rider .....	90
Horse's performance & suitability .....	10
<b>Total .....</b>	<b>100</b>

### Criteria Explanation

**RIDER'S POSITION** – Riders should establish and maintain a seat that is thoroughly efficient and comfortable for riding the type of horse called for, at any gait and for any length of time. The method of holding the reins should be consistent with the type of equipment being used. Both hands should be used and both reins must be picked up at one time. The bight of the reins should be on the off side; the hands should be in line with the bit and the elbows. The leg position should allow the heels to be lower than the toes. No swaying of the legs should be visible. A vertical line drawn from the rider's shoulder downward should

pass through the shoulders, hips and heels. The upper calves of the rider's legs should have contact with the horse.

With gaited horses, the rider's legs may be forward at the knees and will give the impression of a slightly reclined position to the upper torso.

When the horse is moving, the rider's position should change in the following manner:

- **Walk** – Slight motion.
- **Trot or second gait** – Slight elevation with the hips under the body, not swinging forward and backward or moving up and down mechanically. Posting by breed standards.
- **Canter or third gait** – Close seat going with the horse.

**APPOINTMENTS OF HORSE AND RIDER** – See the “English Appointments” section in this division. Saddles and pads are not permitted.

**HORSE'S PERFORMANCE** – The rider will be asked to have the horse walk, trot (or second gait) and canter (or third gait) both ways of the ring. The reverse may be executed by turning either toward or away from the rail. Light contact with the horse's mouth is required. Riders may be asked for individual workouts. The hands, seat and legs are important aids in achieving the desired gait or movement. Use of the third gait by gaited horses will be judged on the smoothness of the transitions.

The emphasis should be on suitability to riding style, manners and way of going. All seats should be given equal consideration.

## Individual Tests

These tests may be performed individually or in a group.

1. Address the reins.
2. Back.
3. Individual performance on the rail.
4. Figure eight at the trot (or second gait), with a correct change of diagonals. At the left diagonal, the rider should be sitting when the horse's left front foot is on the ground. At the right diagonal, the rider should be sitting when the horse's right front foot is on the ground. When circling clockwise, the rider should be on the left diagonal. When circling counterclockwise, the rider should be on the right diagonal.
5. Figure eight at the canter with a change of lead through the walk (figures should begin in the center of two circles so that one lead change is shown).
6. Change leads down the center of the ring or on the rail, with a change of leads through the walk.

7. Answer the judge's questions. It is recommended that the same questions be asked of each rider privately. An example would be one question each about tack, anatomy and equitation.

# Sidesaddle Division

## Sidesaddle (English Saddle Seat)

**APPOINTMENTS OF HORSE** – The use of a modern English side-saddle with or without a balance strap (see fig. 7) is recommended, but antique Victorian sidesaddles are allowed if they are serviceable. Full bridles are preferred, but breed custom may dictate otherwise (such as for Tennessee walking horses or gaited horses). Saddle pads are permitted but must be cut to the shape of the saddle. Martingales, tiedowns, breast collars and sandwich cases are prohibited.

**APPOINTMENTS OF RIDER** – A complete sidesaddle habit is preferred but a conservatively colored saddle coat worn with a matching or contrasting apron is acceptable. Hunt-style breeches must match the color of the apron as closely as possible. Hunt boots are correct, but Kentucky jodhpurs and jodhpur boots are allowed. The apron must always cover the right foot but should never cover the left foot. The apron should fall from 1 to 3 inches above the left ankle and hang level from front to back. Any standard-style saddle seat shirt and tie are acceptable. Gloves and a derby, soft hat or protective headgear that complements or contrasts with the outfit are required. Veils and vest are optional. A whip is optional but it must be of the saddle seat style – never a hunt crop. A spur without a rowel is permitted on the left boot.

## Sidesaddle (English Hunter Seat)

**APPOINTMENTS OF HORSE** – A modern English sidesaddle with a balance strap is required. A full bridle is preferred, but a pelham or snaffle may be used. Saddle pads and stirrup pads are not permitted. A hunting breastplate without a martingale and a sandwich case are optional.

**APPOINTMENTS OF RIDER** – A sidesaddle habit is preferred but a conservatively colored hunt coat with a matching or contrasting apron is acceptable. Breeches must match the color of the apron as closely as possible, and hunt or field boots must be worn. The apron should fit and hang as described in the requirements for Sidesaddle (English Saddle Seat). The shirt may have a ratcatcher with a band or stock tie, or a wing tip collar as described in the requirements for Sidesaddle

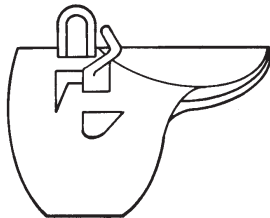

Figure 7. Modern English side saddle.

(English Saddle Seat), with a man's tie. Gloves must be worn and must be made of brown leather, even if the habit is black. Riders must wear protective headgear (see General Rule 3). Veils are optional. A spur without a rowel is permitted on the left boot.

## Sidesaddle (Western)

**APPOINTMENTS OF HORSE** – A western sidesaddle or Victorian sidesaddle must be used. Any standard western bit and bridle may be used. A western saddle blanket or pad should be used and does not need to be cut to fit the saddle. Optional equipment includes a breast collar, hobbles and slicker.

**APPOINTMENTS OF RIDER** – Rider must wear a long sleeved western shirt, long pants tucked into boots, and an apron that matches or contrast with the shirt. A western hat or protective headgear must be worn without an attached veil or flowing band of any sort. Decorative hat bands that do not extend past the brim of the hat are nice, but are not necessary. A vest is optional. A tie is required, and should be as small and tidy as possible. The apron should fit and hang as for Sidesaddle (English Saddle Seat) classes. A western quirt is permitted for riders not using romal reins. A spur, rowelled or unrowelled, may be worn on the left boot.

## Sidesaddle Equitation

Sidesaddle Equitation Criteria	Points
Rider's position & horse's performance.....	90
Appointments of horse & rider.....	10
<b>Total.....</b>	<b>100</b>

### Criteria Explanation

**RIDER'S POSITION** – Establish and maintain a secure seat that is thoroughly comfortable for riding the type of horse at any gait for any length of time. The rider should appear squarely in the middle of the horse's back. The spine of the rider should be directly over the spine of the horse. The back must be straight; leaning to the right is not allowed. The rider's weight is carried on the right thigh, and the rider must not sit heavily on the left seat bone. From the waist up the rider should appear as if astride, with shoulders square to the front. The rider should have a hand's thickness (½ inch to 1 inch) between the left thigh and the leaping head. Gripping up under the leaping head should be done only in an emergency. The left heel should be level or slightly down. The right toe should hang down and turn into the horse's shoulder, as this is the rider's true safety grip. The method of holding the reins should be consistent with the type of equipment being used. With English equipment, the bight of the reins is carried on the right

side. The elbows must be over the hips and the hands should be in a line from the bit to the elbow. Sidesaddle extends the line by about eight inches, but does not change it. See figure 8 for the correct rider position.

**HORSE'S PERFORMANCE** – The rider should have the horse walk, trot or jog (or second gait) and canter or lope (or third gait) both ways of the ring. English riders may be asked to extend the trot. Riders may sit or post the trot, but sitting is preferred.

In open equitation classes, sidesaddle riders must post as do the other riders in the class. English or western riders may be asked to gallop. Sidesaddle riders may be asked for any test that astride riders are asked to perform.

**APPOINTMENTS OF HORSE AND RIDER** – See the "Appointments" section in this division.

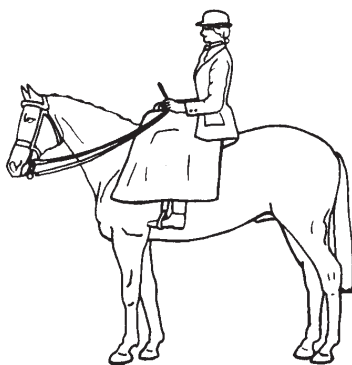

Figure 8. Correct seat & hands for sidesaddle equitation.

## Sidesaddle Pleasure

Sidesaddle Pleasure Criteria	Points
Horse's performance & manners.....	90
Appointments of horse & rider.....	10
<b>Total.....</b>	<b>100</b>

### Criteria Explanation

**HORSE'S PERFORMANCE AND MANNERS** – The horse is to be shown at a walk, trot or jog (or second gait), extended trot (English only), and canter or lope (or third gait) both ways of the ring. A hand gallop is permissible, but no more than eight horses at a time should be asked to hand gallop. Horses should stand quietly and back readily. Horses are judged on manners, quality, performance and suitability of horse to rider. Horses should be severely penalized for traveling with their quarters off the rail. Horses must be serviceably sound. See figure 8 for the correct rider position.



## Dressage Division

**APPOINTMENTS OF HORSE** – Rider must use a plain snaffle bit and English snaffle bridle with cavesson, flash, figure-eight or dropped noseband. Hunt or dressage saddles are permitted. No boots or bandages are allowed. Martingales and side reins, or running reins, are prohibited. Whips measuring 4 feet or less (including the lash) are allowed. Only blunt English spurs are allowed.

**APPOINTMENTS OF RIDER** – A derby, hunt cap or other protective headgear is required; however, headgear should be appropriate to the riding style. ASTM-SEI approved helmets are acceptable for any riding style. A choker or pin for girls and a tie for boys are acceptable. White stock ties and stock pins are also correct for both boys and girls. A dark hunt coat with white, grey or light tan breeches and black boots are acceptable.

### Overview

The object of dressage is the harmonious development of the physique and ability of the horse. In accordance with U.S. Dressage Federation (USDF) recommendations, it is suggested that horses be more than 36 months of age (as measured from their foaling date) before competing in any dressage class. Dressage training makes the horse not only calm, supple, loose and flexible, but also confident, attentive and keen, thus allowing it to achieve perfect understanding with its rider. These qualities are revealed by the:

- Freedom and regularity of the gaits.
- Harmony, lightness and ease of the movements.
- Lightness of the forehand and the engagement of the hindquarters, originating in a lively impulsion.
- Acceptance of the bridle, with submissiveness throughout the head, neck and body, and with no signs of tenseness or resistance.

Emphasis should be placed on suppleness, basic gaits, figures, impulsion and transitions in the performance of the horse as produced by the rider. Conformation does not count.

**Horse's Performance** – The following points are considered in judging dressage classes.

- **Halt** – At the halt, the horse should stand motionless, straight and attentively, with the weight distributed evenly over all four legs, which should be in pairs abreast with each other.
- **Working walk** – A marching gait in which the footfalls of the horse's feet follow one another in four-beat time, well-marked and maintained in all work at the walk.

• **Free walk on a loose rein** – The free walk is a relaxing gait in which the horse is allowed complete freedom to lower and stretch out its head and neck.

• **Free walk on a long rein** – This gait gives the horse freedom to lower and stretch out its head and neck, while the rider still maintains contact.

• **Working trot** – The working trot is a two-beat gait. It should always be done with free, active and regular steps, and it should be moved into without hesitation. The horse should maintain rhythm and balance.

• **Lengthened trot** – This trot is the same as the working trot except that the frame and stride of the horse must lengthen without a change in rhythm or speed.

• **Working canter** – The canter, at a three-beat pace, should be light and cadenced, with regular strides, and should be moved into without hesitation.

• **Lengthened canter** – Same as the working canter except that the frame and stride of the horse must lengthen without a change in rhythm or speed.

• **Transitions** – The change of gait and speed should be smooth and not abrupt. The rhythm of the pace should be maintained up to the moment when the gait is changed.

• **Direction changes** – These changes should be performed without resistance or change of gait, rhythm or speed.

• **Rider** – The rider's upper body should be erect yet relaxed, resting steadily on the pelvis. The lower back should be supple to absorb the motion of the horse's stride. The legs should be steady and the thighs stretched well downward. The rider's upper arms should remain close to the body, with the hands establishing a position over the withers of the horse so there is a straight line from the rider's elbow to the bit. Riding with both hands is obligatory unless otherwise specified.

The seat of the saddle should always have the deepest point in the middle, and the rider should sit exactly in the middle of the saddle. In this position, the rider is able to apply the aids unobtrusively and can follow the activity of the horse without interfering with the horse's movements. The position is correct when the rider can control the horse through the influence of his or her seat and with quiet hands and steady contact with both legs.

### Execution of Tests

**1. Voice** – Voice signals and clicking the tongue are a 2-point penalty.

**2. Errors** – When a rider makes an error in the course, the judge should sound a bell or whistle. The judge should then, if necessary, show the rider the point at which he or she must take up the test again and the next movement to be executed. The judge then leaves the

rider to continue by himself or herself. A course error includes such faults as taking a wrong turn or omitting a movement.

When the rider makes an error of test (for example, rising instead of sitting), the judge does not necessarily ring the bell but should note the error.

All errors should be penalized in the following manner: 2 points for the first error, 4 points for the second and elimination for the third (although the rider may finish the test), with the marks being awarded in the ordinary way.

**3. Lameness** – In cases of marked lameness, the judge or show committee must eliminate the contestant.

**4. Reading Tests** – Tests may be read during the competition but no part of a test may be read more than once. Lateness or errors in reading the ride will not relieve the rider from error penalties. Coaching by anyone is prohibited and will result in the elimination of the rider. If part of the test is repeated, it may be scored as an error.

**5. Falls** – In case of a fall by horse or rider, the competitor will not be eliminated. He or she will be penalized according to the fall's effect on the movement being executed. The rider will also be penalized in the collective marks.

**6.** A competitor leaving the arena at the end of a ride at any point other than "A" will be penalized with an error.

**7.** If during the test the horse leaves the arena by placing all four feet outside the fence or line marking the perimeter of the area, the competitor is eliminated.

### Dressage Tests

Dressage tests are rewritten by the U.S. Equestrian Federation (formerly USA Equestrian) every four years. Each USEF test change is reflected in a change in tests used at Michigan 4-H horse shows. The tests and levels offered by a 4-H show are to be listed on the show's prize list. The U.S. Dressage Federation (USDF) Level 1 and 2 walk-trot tests may be used for inexperienced riders in their first year of showing or for green horses that have not yet been shown under saddle at a canter. Copies of introductory dressage tests are available at no charge from USDF online at [usdf.org](http://usdf.org).

### Scoring Dressage Tests

Dressage tests for the State 4-H Horse Show are obtained at no charge from USEF at [usef.org](http://usef.org). Printed copies of current dressage tests should be used to score the ridden tests. (The local show committee must provide the judge with score sheets.) The judge should be given a table and a recording secretary. The recorder writes the judge's numerical scores from 0 to 10 in column 4 of the test sheet. He or she also records the judge's remarks in column 7. It is recom-

mended that the judge's comments conform to the USDF Glossary of Dressage Judging Terms.

The judge refers to "directive ideas" (column 3), which tell the judge and rider which aspects of the movement will be given heaviest consideration. The fourth column is used to record the numerical score:

10 = Excellent	6 = Satisfactory	2 = Bad
9 = Very good	5 = Sufficient	1 = Very bad
8 = Good	4 = Insufficient	0 = Not executed
7 = Fairly good	3 = Fairly bad	

The fifth column states the coefficient for the numerical score for a particular movement.

The sixth column is for the total points earned for the section (for example, the raw score multiplied by the coefficient). If no coefficient exists, the raw score should be transferred to this column.

The sixth column should be totaled, and this figure entered on the sub-total line; errors should be listed on the next line and then subtracted to obtain the "total points." This figure will then be divided by the total number of points possible for the test to give a percentage score. This percentage score is used to place the class. Should two riders have the same percentage score, the judge will break the tie; a plus (+) mark will be placed behind the percentage score of the preferred rider (for example, 1st place 58.66%+; 2nd place 58.66%). The judge must take care when entering comments in column 7, because the descriptive words for each numerical score should only be used with that numerical score.

Except for the last section in the collective marks at the end of the test, the entire test is judged on the correctness of the horse's movements, not on the rider. The rider is judged directly only in the collective marks. Indirectly, the rider is judged throughout the test, as any interference or incorrectly applied aids will affect the correctness of the horse's movements.

It is important that the progressive nature of the tests and levels be taken into consideration in scoring and interpreting test scores. A movement which may score a "7" at training level test one may only score a "5" at first level test one. Directive ideas are given on the front of the score sheets, and provide the rationale behind the particular test. Scores must be understood in relationship to the directive ideas for that test and level.

Accuracy should be a factor only if the inaccuracy avoids the difficulty of the movement, for example, completing a larger circle avoids the difficulty of completing a 10-meter circle. Movements that must be carried out at a certain point of the arena should be done at the moment when the competitor's body is above this point.

If a problem such as nodding, stumbling or shying appears once, it may be treated lightly by the judge; if the same problem appears successively, the judge will score it more harshly each time.

Grinding of the teeth and wringing of the tail are signs of tenseness or resistance on the part of the horse and should be considered in the marks for each movement where they appear, as well as in the collective marks. Horses that get their tongues over the bit or perform with an open mouth must be marked down.

Horses that enter the arena with their tongues tied down will be eliminated.

Any prolonged resistance that prevents the continuation of the test for longer than 20 seconds may be punished by elimination.

**ELIMINATION** – Horse and rider will be eliminated under the following circumstances:

- Use of illegal equipment
- Unauthorized assistance
- Three errors of the course
- Horse's tongue tied down
- Late entry into the arena
- All four of the horse's feet leave the arena
- Cruelty
- Marked lameness

### Bits Permitted in Dressage

The following bits (see fig. 9) may be used in dressage classes:

1. Ordinary snaffle with single-jointed mouthpiece.
2. Ordinary snaffle with double-jointed mouthpiece.
3. Racing snaffle (D-ring).
4. Snaffle.
  - a. With cheeks, with or without keepers.
  - b. Without cheeks (egg-butt).
5. Snaffle with upper or lower cheeks.
6. Unjointed snaffle (mullen-mouth).
7. Snaffle with cheeks. (Hanging or drop cheek; Baucher). This may be a D-ring or other ordinary snaffle as pictured in numbers 1 to 6.
8. Dr. Bristol.
9. Fulmer.
10. French snaffle.
11. Snaffle with rotating mouthpiece.

Any of the bits listed above may be made with a rubber, plastic or leather covering, but the bit may not be modified by adding latex or

other material. Bits with mouthpieces made of synthetic material are permitted, provided that the contours of the bit conform to the contours of one of the bits pictured above. Flexible rubber or synthetic mouthpieces are permitted.

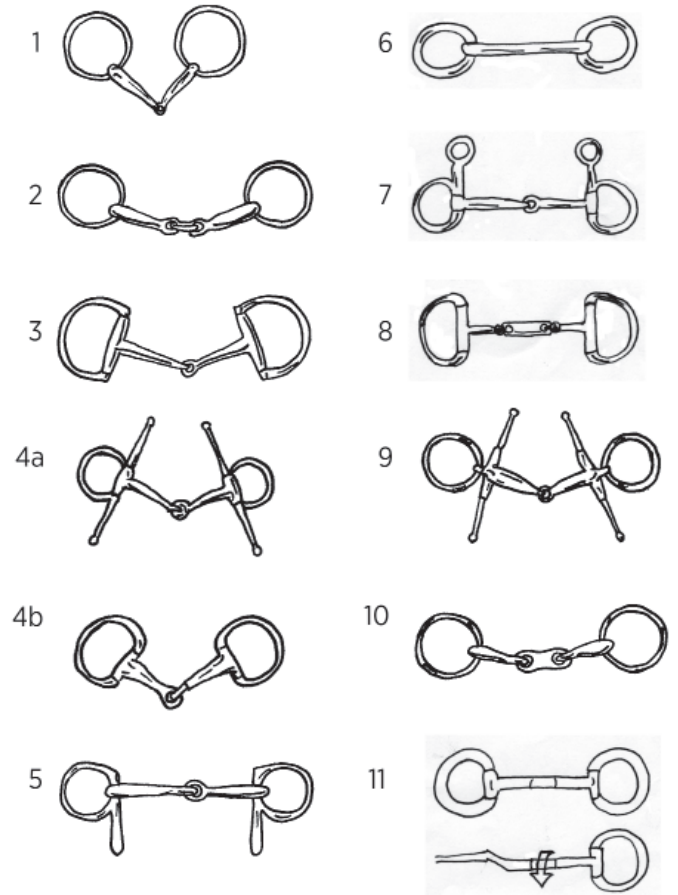

Figure 9. Bits permitted in dressage.

Dressage Arena Layout

Training level tests may be ridden in a standard 20 meter by 60 meter arena (see fig. 10) or a 20 meter by 40 meter arena (see fig. 11). First level tests and all higher tests must be ridden in a standard 20 meter by 60 meter arena. The site chosen for the arena must be as level and quiet as possible. If there is only one judge, he or she is placed 5 meters from the arena behind the letter C. The public, as well as horses and riders not involved in a test, should be kept at least 20 meters away from the arena to avoid distracting the horse and rider riding a test. Corners of the arena must be clearly marked with planks or boards if regular fencing is not used.

Suitable to Become a Dressage Horse

This class is open to horses that have not competed in any tests above the first level. The class is to be shown at a walk, trot and canter both ways of the ring, and is to be judged on the horse's potential to become a dressage mount. Ninety percent of the judging is on the horse's gaits, impulsion, attention and confidence, harmony, lightness and ease of movements, and acceptance of the bit. Ten percent is on the appointments of the horse and rider. The horse must be serviceably sound.

Dressage Seat Equitation

Dressage Seat Equitation Criteria	Points
Rider's position & appointments of horse & rider .....	100
<b>Total .....</b>	<b>100</b>

Criteria Explanation

**RIDER'S POSITION AND PERFORMANCE** – All of the movements should be obtained without apparent effort on the part of the rider. He or she should be well-balanced and hips supple, with the thighs and legs steady and well-stretched downward. The upper part of the body should be easy, free and erect. The hands should be held low and close together without touching each other or the horse, and with the thumbs as the highest point. The elbows and arms should be held close to the body, enabling the rider to follow the movements of the horse smoothly and freely and to apply aids imperceptibly. This is the only position that makes it possible for the rider to school the horse progressively and correctly. Not only the aids of the hands and legs, but also of the seat, are of great importance in dressage.

Standard Arena

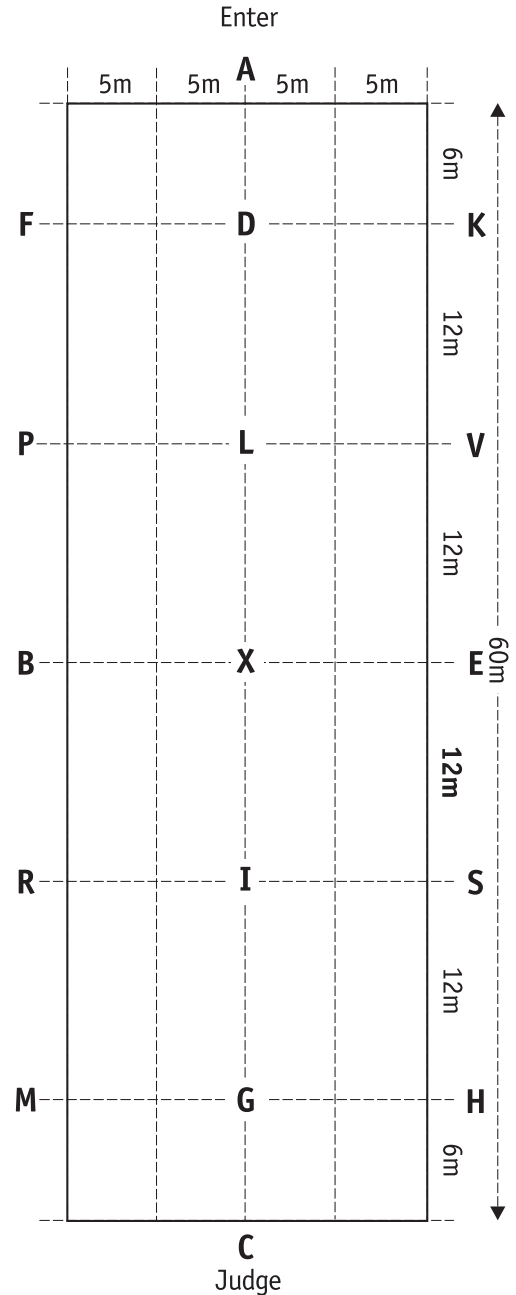

1 meter = 3.3 feet

Figure 10. Large dressage test arena layout.

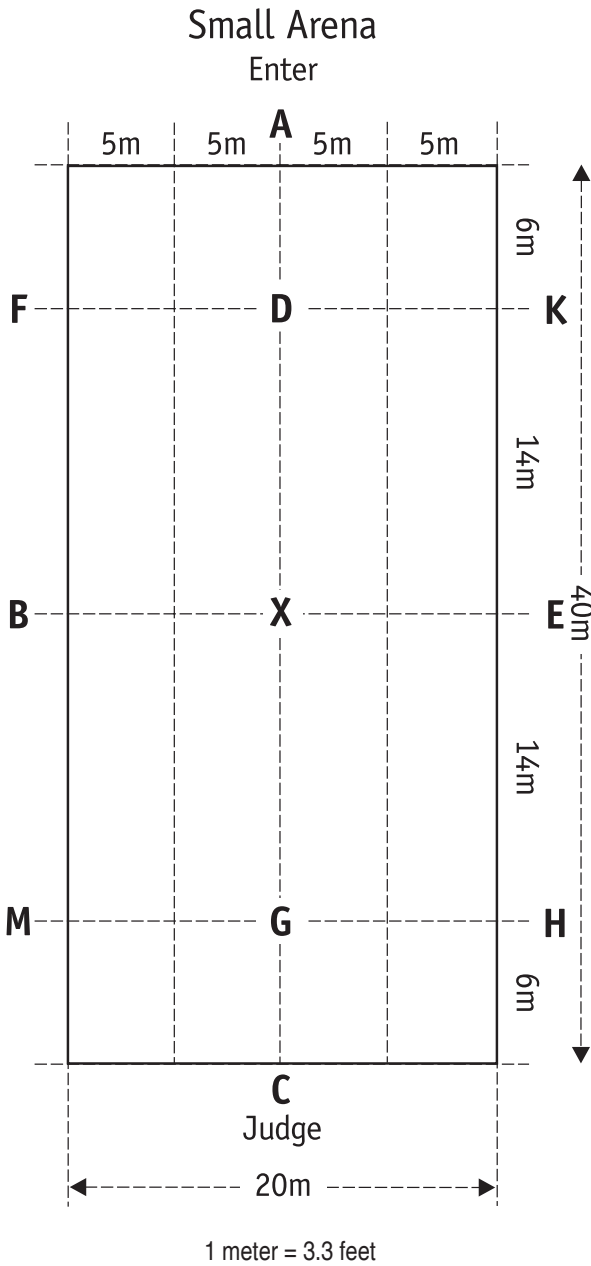

Figure 11. Small dressage test arena layout.

**Evaluating the Rider's Position and Performance** – The basic picture (see fig. 12) includes the ear, shoulder, hip and heel being aligned with the vertically hanging stirrup leather, heels down. The trunk is upright with the chest open and the spine aligned, with the rider looking up. There is a straight line from the rider's elbow to the horse's mouth. The rider's upper arm is almost vertical.

**Legs:**

- Centered under body.
- Heels down slightly, iron on ball of foot with weight evenly distributed. Angle to hip, knee and ankle allow the rider to sit in balance with the horse and absorb the motion of the horse's movement
- Knee low, thigh stretched down to adhere to horse.
- Inside of calf lying close to and lightly on horse's side.
- Quiet legs.

**Seat and Upper Body:**

- Sits centered on the horse.
- Sits in deepest part of the saddle, which should be more toward the front of the saddle than the cantle.
- Sits deeply in the saddle with the upper body controlled but moving with the horse.
- Hips and lower back supple, allowing them to follow the motion of the horse.

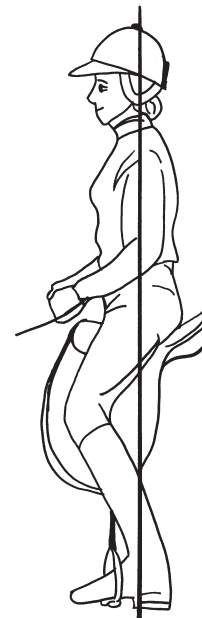

Figure 12. Correct position of the dressage rider.

- Shoulders balanced over the hips.
- Head balanced over shoulders, with chin level.
- Rider looking over horse's ears.

### Use of Aids:

- Aids invisible.
- Horse performs well, is relaxed, has rhythmic gaits, is energetic, supple and balanced.
- Correct timing of aids.
- Correct use of half halts.

**FAULTS** – The following faults will be considered in evaluating the exhibition:

### Legs:

- Thigh or knee coming up.
- No contact with the horse's side.
- Lower leg gripping.
- Spur held in horse's side or constantly poking into the horse.
- Loss of stirrup.
- Slightly forward or back.
- Stirrups too short so that use of the leg is restricted.
- Stirrups too long so toe is down or there is no flexibility to ankle.
- Slight movement to legs.
- Stirrups uneven.
- Uneven weight in stirrups.
- Stirrup leather twisted.
- Stirrup on toe or "home."
- Bracing on stirrup.
- Unnecessary lifting of heel to give aid.
- Swinging legs.
- Knee off saddle.
- Toe pointed out excessively so back of calf and heel are on the horse.
- Toe pointed in excessively with all of weight on outside of stirrup.
- Rigid ankles.

### Seat and Upper Body:

- Extreme crookedness.
- Rider's head dropped down.
- Unable to sit in saddle.
- Excessive motion.
- Sits to one side.

- Slightly ahead of the motion.
- Slightly behind the motion.
- One shoulder or hip higher or lower than the other.
- One shoulder or hip further forward than the other.
- Slight rigidity or stiffness.
- Rounded back.
- Excessively swayed back.
- Collapsed chest.
- Loss of rhythm with horse.
- Chin down.
- One ear lower than the other.
- Tension in buttocks, back or shoulders.
- Hanging or pulling on horse's mouth.
- Hands constantly busy.
- Major rigidity or tension in arms and hands.
- Hands too high.
- Hands too wide apart.
- Hands too low.
- Flat hands.
- Elbows too far back.
- Elbows straight.
- Slight rigidity or tenseness.
- Loss of contact with mouth.
- Lack of following arm.

### Use of Aids:

- Lack of relaxation, impulsion, rhythm, suppleness and balance caused by the rider.
- Wrong diagonal or incorrect lead uncorrected.
- Break in gait poorly corrected.
- Loss of control and unsafe riding (including getting too close to other riders).
- Lack of preparation/poor half halts.
- Aids obvious.
- Inappropriate use of whip.
- Inappropriate use of spur.
- Horse resisting.
- Horse above or behind bit.
- No bend.

- Incorrect diagonal or lead quickly and quietly corrected.
- Break in gait quickly and quietly corrected.
- Horse lacking relaxation, impulsion, rhythm, suppleness and balance.

**APPOINTMENTS OF HORSE AND RIDER** – See the “Appointments” section in this division.

**PERFORMANCE OF HORSE AND RIDER** – The class is open to horses and ponies and is to be shown on the rail at a medium walk, working trot (sitting and rising) and canter both ways of the ring. It is to be judged entirely on the rider’s position, seat, and correct use and effect of the aids as required by training and first-level dressage, however, lameness will be penalized. This class may be conducted in a large enclosed arena, an open schooling area or in the standard (large) dressage arena. (If it is held in the dressage arena, no more than six riders may be asked to canter at the same time.)

### Individual Tests

The judge may, at his or her discretion, ask selected riders to perform the following movement, either individually or in small groups:

- Transitions
- Leg yield
- Changes of lead through the trot
- Serpentine at the trot
- Shallow-loop serpentine with counter canter
- Trot or canter lengthening, or both
- Riding without stirrups

## Western Riding Division

### WESTERN APPOINTMENTS

**APPOINTMENTS OF HORSE** – The western bit, bridle and saddle should fit the horse and rider. Horses aged 6 and up must be ridden with standard western bits, which are bits with shanks and mouthpieces varying from straight to full spade, with a curb strap. Jointed mouthpieces are permitted so long as the bit has shanks and a curb strap (such as a Tom Thumb snaffle). The curb strap or chain should be loose enough to allow a person to insert about two stacked fingers between it and the horse’s chin.

Riders whose horses are aged 5 years and under have the option of using a standard western bit (as described above), a bosal or a smooth, broken mouthpiece snaffle as listed in the “Western Snaffle Bit” section. A loose curb strap is optional, but must be solid leather or nylon only and must be attached below the reins.

Hackamore bits, running martingales, tiedowns and nosebands are prohibited in any western class other than gymkhana. Draw reins are also prohibited in the show ring. No wire curbs, regardless of how well they are padded or taped, are permitted. No curb chains or straps narrower than ½ inch are permitted. Tapaderos are discouraged. Optional equipment includes ropes, reatas and hobbles, slickers and breast collars.

**APPOINTMENTS OF RIDER** – The rider must wear a western hat or protective headgear, western boots (**fashion heels are prohibited**), a long-sleeved shirt with a collar (including standup, tuxedo, oxford, button-down, turtleneck and mock turtleneck collars) and long pants. If the pants have belt loops, a belt must be worn. A tie, pin, choker, necklace or scarf is required for open-collared shirts. Chaps, gloves and spurs are optional, but spurs must not harm the horse.

### Western Bits

References to a standard western bit in western performance classes refers to the use of a curb bit that has a solid or broken mouthpiece, has shanks and acts with leverage. Curb bits are reined with one hand at all times, and the rider may not change hands on the reins. Using two hands on a curb bit will result in disqualification. All curb bits must be free of mechanical devices and should be standard western bits. A description of a legal, standard western bit includes:

1. The maximum length of the shank is 8.5 inches. Shanks may be fixed or loose.
2. Concerning mouthpieces, bars must be round, smooth and unwrapped metal of 5/16-inch to 3/4-inch in diameter, measured 1 inch from the cheek. They may be inlaid, but must be smooth or latex

wrapped. Nothing (including extensions or prongs) may protrude below the mouthpiece on solid mouthpieces. The mouthpiece may be two or three pieces. A three-piece connecting ring of 1¼ inch or less in diameter, or a connecting flat bar of 3/8 inch to 3/4 inch or less in diameter, or a connecting flat bar of 3/8 inch to 3/4 inch (measured top to bottom with a maximum length of 2 inches), which lies flat in the horse's mouth, is acceptable. (See fig. 13 for how to measure a curb bit.)

3. The port must be no higher than 3½ inches, with rollers and covers acceptable. Broken mouthpieces, halfbreeds and spades are standard.

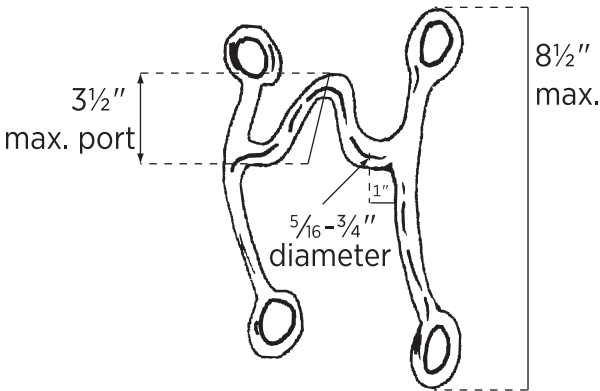

Figure 13. How to measure a curb bit.

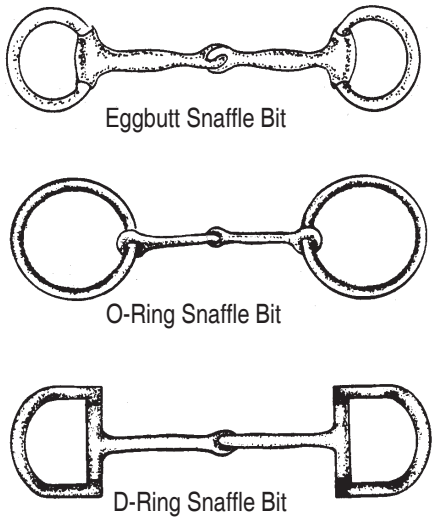

Figure 14. Examples of acceptable bits for western snaffle bit horses.

Contestants must be penalized for incomplete appointments. The penalty will depend on the nature and extent of the omissions or the inappropriateness of the appointments. Exhibitors and judges should remember at all times that entries are to be judged on ability rather than on personal attire.

Western Snaffle Bit

**APPOINTMENTS OF HORSE** – Horses aged 2 to 5 may be shown in a standard plain or silver mounted western headstall (browband, shaped ear or split ear). The bridle should have a **smooth snaffle bit** (no shank) with a broken mouthpiece (eggbutt, O-ring or D-ring, see fig. 14) with rings no larger than 4 inches and no smaller than 2 inches in diameter. From the horse's cheek to 1 inch in from the cheek, the bit must be a minimum of 3/8 inch in diameter with a gradual decrease to the center of the snaffle. (See fig. 15 for how to measure a snaffle bit.)

Split reins are mandatory and can be standard leather or woven. Hair reins are not permitted with snaffle bits.

A braided rawhide or leather bosal (see fig. 16) may be used instead of a snaffle bit. The bosal can be no wider than 3/4 inch in diameter at the cheek, and there must be a minimum of one finger space (approximately 3/4 inch) between the bosal and the horse's nose. Absolutely no metal under the jaw or noseband in connection with the bosal will be allowed. The bosal should be properly fitted relative to the horse's size and conformation.

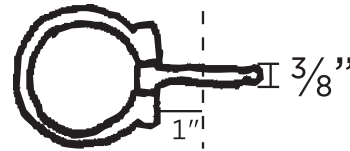

Figure 15. How to measure a snaffle bit.



## GAITS

The following terms apply in all western classes whenever a specific gait is called for:

- **Walk** – A natural, flat-footed, four-beat gait. The horse must move straight and true at the walk. The horse must be alert with a stride of reasonable length in keeping with its size.
- **Jog-Trot or Jog** – A smooth, ground covering, two-beat diagonal gait. The horse works from one pair of diagonals to the other pair. The jog-trot should be square and balanced with a straight, forward movement of the feet. Horses walking with their back feet and trotting on their front feet are not performing the required gait. When asked to extend the jog, the horse moves out with the same smooth way of going; however, the stride should be lengthened. The pace should not quicken.
- **Lope** – An easy, rhythmical, three-beat gait. Horse moving to the left should lope on the left lead. Horses moving to the right should lope on the right lead. Horses traveling at a four-beat gait are not performing a proper lope. The horse should lope with a natural stride and appear relaxed and smooth. The horse should be ridden at a speed that is natural. The head should be carried at an angle that is natural and suitable to the horse's conformation at all gaits.
- **Reverse** – The reverse may be executed by turning either toward, or away from, the rail.

Horses that normally perform alternate second or third gaits should be considered equally and **judged according to their own breed specifications**.

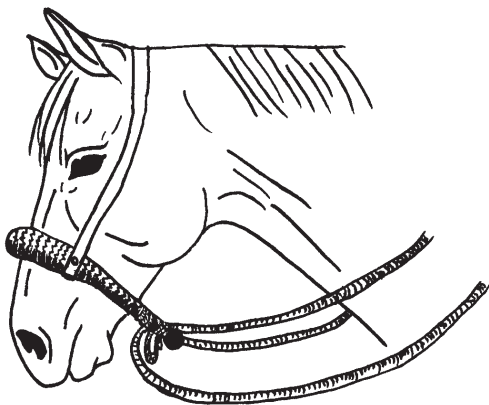

Figure 16. A properly fitted bosal.

## WESTERN CLASSES

### Stock Seat Equitation (Western Horsemanship)

Stock Seat Equitation Criteria	Points
Hands, seat, suitability, & appointments of horse & rider .....	90
Horse's performance .....	10
<b>Total .....</b>	<b>100</b>

#### Criteria Explanation

**HANDS** – Both hands and arms should be held in a relaxed, easy manner with the upper arms in a straight line with the body. The arm that holds the reins should be bent at the elbow. When using a romal, the rider's off hand should be around the romal, provided it is held a least 16 inches from the reining hand. Some movement of the arm is allowed, but excessive pumping will be penalized. Hands are to be around the reins.

One finger between the reins is permitted when using split reins, but not with a romal. The reins are to be carried immediately above or slightly in front of the saddle horn. When riding in a curb bit, only one hand should be used for reining, and that hand may not be changed. The reins should be carried so there is light contact with the horse's mouth; at no time should the reins be carried more than a slight hand movement away from contact with the horse's mouth.

**Seat** – The rider's body should always appear comfortable, relaxed and flexible (see fig. 17). The stirrups should be just short enough to allow the heels to be lower than the toes. The feet should be placed in the stirrups with weight on the ball of the foot. Consideration, however should be given to the width of the stirrups, which varies on western saddles. The rider should sit the saddle to jog and not post, even if an extended trot is called for. At the lope, he or she should be close to the saddle. All movements of the horse should be governed by the use of undetectable aids.

**APPOINTMENTS OF HORSE AND RIDER** – See the "Western Appointments" section in this division.

**HORSE'S PERFORMANCE** – The rider must have the horse walk, jog (or second gait), lope (or third gait), reverse either way, pass on the inside and neck rein. The rider should be able to perform other routines. **In all western classes, if a horse and rider are traveling in a proper manner, they should not be penalized for safely passing another horse.**

Individual Tests

These tests may be performed either individually or in a group.

1. Individual performance on the rail.
2. Figure eight at the jog-trot (or second gait).
3. Lope and stop.
4. Figure eight at the lope on the correct lead with a simple change of lead (that is, a lead change in which the horse is brought back to a walk or jog-trot and is restarted into a lope on the opposite lead). Figures are begun in the center of two circles so that one lead change is shown. Use of the third gait by gaited horses will be judged on smoothness of transitions.
5. Ride without stirrups.
6. Figure eight at the lope on the correct lead, with a flying change of lead.
7. Change leads while moving straight down the center of the ring, with a simple change of lead.

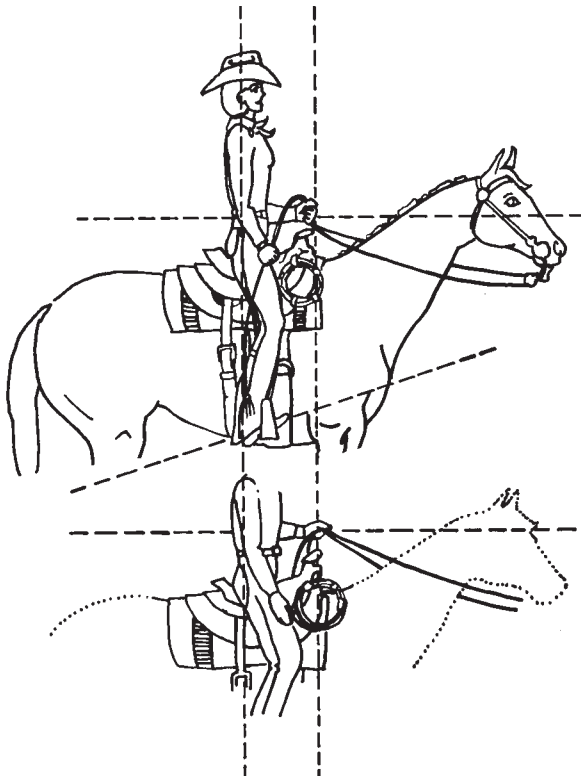

Figure 17. Correct rider position for stock seat equitation.

8. Ride a serpentine course, with simple or flying changes of lead in each direction, as directed by the judge.
9. Sliding stop.
10. 360-degree spins.
11. One or more roll backs.
12. Counter canter 15 feet from rail.
13. Back.
14. Answer the judge's questions. It is recommended that the same questions be asked of each rider privately. (For example, one question each on tack, anatomy and equitation.)
15. A test comprised of one or more of the above tests.

Bareback Western Equitation

Bareback Western Equitation Criteria	Points
Rider position, suitability, & appointments of horse & rider .....	90
Horse's performance .....	10
<b>Total .....</b>	<b>100</b>

Criteria Explanation

**HANDS** – Both hands and arms should be held in a relaxed, easy manner with the upper arms in a straight line with the body. The arm that holds the reins should be bent at the elbow. When using a romal, the rider's off hand should be around the romal, provided it is held at least 16 inches from the reining hand. Some movement of the arm is allowed, but excessive pumping will be penalized. Hands are to be around the reins.

One finger between the reins is permitted when using split reins, but not with a romal. Only one hand should be used for reining, and that hand should not be changed. The reins should be carried so there is light contact with the horse's mouth; at no time should the reins be carried more than a slight hand movement away from contact with the horse's mouth.

**SEAT** – The rider's body should always appear comfortable, relaxed and flexible. The leg position should allow the heels to be lower than the toes. The rider should sit the horse at the jog or second gait and not post, even if an extended trot is called for. At the lope or third gait, he or she should be close to the horse. All movements of the horse should be governed by the use of undetectable aids.

**APPOINTMENTS OF HORSE AND RIDER** – See the "Western Appointments" section in this division. Saddles and pads are not permitted.

**HORSE'S PERFORMANCE** – The rider must have the horse walk, jog (or second gait), lope (or third gait), reverse either way, pass on the inside and neck rein. The rider should be able to perform other routines. If a horse and rider are traveling in a proper manner they should not be penalized for safely passing another horse.

**Individual Tests**

These tests may be performed either individually or in a group.

1. Individual performance on the rail.
2. Figure eight at the jog-trot (or second gait).
3. Lope and stop.
4. Figure eight at the lope (or third gait) on the correct lead with a simple change of lead (that is, a lead change in which the horse is brought back to a walk or jog-trot and is restarted into a lope on the opposite lead). Figures are to begin in the center of the two circles so that one lead change is shown. Use of the third gait by gaited horses will be judged on smoothness of transitions.
5. Figure eight at the lope on the correct lead, with a flying change of lead.
6. Change leads while moving straight down the center of the ring, with a simple change of lead.
7. Counter canter 15 feet from the rail.
8. Back.
9. Answer the judge's questions. It is recommended that the same questions be asked of each rider privately. (For example, one question each on tack, anatomy and equitation.)
10. A test comprised of one or more of the above tests.

**Western Pleasure**

Western Pleasure Criteria	Points
Horse's performance, manners & quality of movement.....	90
Appointments of horse & rider .....	10
<b>Total .....</b>	<b>100</b>

**Criteria Explanation**

**HORSE'S PERFORMANCE AND MANNERS** – The rider must have the horse walk, jog (or second gait), and lope (or third gait), with light contact on the horse's mouth. Passing is to be on the inside. Extended gaits may be requested by the judge. Horses are to be judged on quality, performance, manners and suitability to the rider. The horse must be serviceably sound.

A good pleasure horse has a stride of reasonable length in keeping with its conformation. The horse has enough angle to its pastern to give the rider a pleasant, smooth ride. The horse carries its head in a natural position consistent with its breed standard – not too high or too low, not overflexed at the poll nor excessively nosed out. Credit should be give to a horse that is relaxed but has its ears alert, that looks balanced in its way of going, and is bright as well as responsive to the reins. If asked to extend the jog, it moves out with the same smooth way of going. The horse should not appear sullen, dull, lethargic, drawn or overly tired.

**APPOINTMENTS OF HORSE AND RIDER** – See the “Western Appointments” section of this division.

**FAULTS** – The following faults will be considered in evaluating the exhibition:

- Excessively slow walk.
- Trotting behind while loping, not exhibiting a three-beat lope.
- Failure to perform a two-beat jog; failure to jog both in front and behind (with the exception of gaited horse performing a second gait).
- Overflexion at the poll, indicating intimidation, or “nosing out,” indicating a lack of respect for the bit.
- Sour ears, switching tail and lugging on the bit.
- Altered tail carriage.
- Opening the mouth, failure to change gaits, wrong leads.

**Western Snaffle Bit**

Western Snaffle Bit Criteria	Points
Horse's performance, manners & quality of movement.....	90
Appointments of horse & rider .....	10
<b>Total .....</b>	<b>100</b>

**Criteria Explanation**

Riders must show with both hands on the reins and maintain light contact with the horse's mouth. For split reins, the right rein should pass through the right hand first, then through the left hand with the end of the rein on the left. The left rein should pass through the left hand first, then through the right hand with the end of the rein on the right (see fig. 18).

The rider's hands should be carried near the pommel and no more than 4 inches out on either side of the saddle horn. The rider's hands must be steady with very limited movement, and should be visible to the judge at all times.

**HORSE'S PERFORMANCE AND MANNERS** – See the “Western Pleasure” section in this division.

**APPOINTMENTS OF HORSE AND RIDER** – See the “Western Appointments” section in this division.

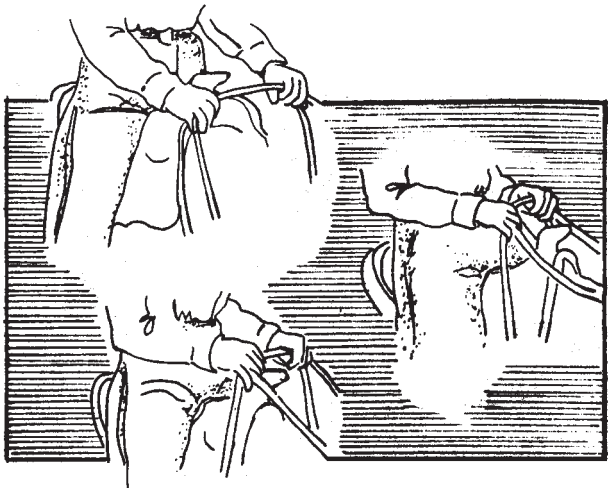

**Figure 18.** Acceptable hand positions for riders of western snaffle bit horses.

## Reining Division

“To rein a horse is not only to guide him, but also to control his every movement. The best reined horse should be willingly guided or controlled with little or no apparent resistance and dictated completely.”  
(2000 National Reining Horse Association Pattern Book)

**APPOINTMENTS OF HORSE AND RIDER** – See the “Western Appointments” section of this division. Skid boots, splint boots and protective leg wraps are optional in reining classes.

The judge will indicate the length of the pattern with markers on the arena fence or wall. Markers within the area of the pattern may be used as a guide, but circles, figure eights and other movements do not have to be performed within the markers.

### Reining Pattern I

See figure 19 for a diagram of reining pattern 1.

1. Run with speed to the far end of the arena past the end marker and do a left rollback – no hesitation.
2. Run to the opposite end of the arena past the end marker and do a right rollback – no hesitation.
3. Run past the center marker and do a sliding stop. Back up to the center of the arena or at least 10 feet (3 meters). Hesitate.
4. Complete one spin to the right. Hesitate.
5. Complete one and one-quarter spins to the left so that the horse is facing the left wall or fence.
6. Beginning on the left lead, complete two circles to the left, with the first circle large and fast, and the second circle small and slow. Change leads at the center of the arena.
7. Complete two circles to the right, with the first circle large and fast, and the second circle small and slow. Change leads at the center of the arena.
8. Begin a large, fast circle to the left but do not close this circle. Run straight up the right side of the arena past the center marker and do a sliding stop at least 20 feet (6 meters) from the wall or fence. Hesitate to demonstrate you have completed the pattern.
9. Dismount and drop the bridle to the designated judge.

Reining Pattern 2

Exhibitors may walk or trot their horses to the center of the arena. Horses must walk or stop before starting the pattern. Begin at the center of the arena facing the left wall or fence. (See fig. 20 for a diagram of reining pattern 2.)

1. Complete one spin to the right. Hesitate.
2. Complete one spin to the left. Hesitate.
3. Beginning on the left lead, complete two circles to the left, with the first circle large and fast, and the second circle small and slow. Change leads at the center of the arena.
4. Complete two circles to the right, with the first circle large and fast, and the second circle small and slow. Change leads at the center of the arena.
5. Begin a large fast circle to the left but do not close this circle. Run up the right side of the arena past the center marker and do a right roll-back at least 20 feet (6 meters) from the wall or fence – no hesitation.
6. Continue back around the previous circle but do not close this circle. Run up the left side of the arena past the center marker and do a left rollback at least 20 feet (6 meters) from the wall or fence – no hesitation.
7. Continue back around previous circle but do not close this circle. Run up the right side of the arena past the center marker and do a sliding stop at least 20 feet (6 meters) from the wall or fence. Back up at least 10 feet (3 meters). Hesitate to demonstrate that you have completed the pattern.
8. Dismount and drop the bridle to the designated judge.

Criteria Explanation

Judges are encouraged to score reining classes according to the NRHA scoring system, which states that all riders will enter the class with a score of 70, which represents an average run. (Scoresheets are available online at [nrha.com/forms/judgesscorecard.pdf](http://nrha.com/forms/judgesscorecard.pdf).) That score is added to or subtracted from as maneuvers are performed and penalties are added. Each maneuver should be scored according to the following scale:

- 1½ = extremely poor
- 1 = very poor
- ½ = poor
- 0 = correct
- +½ = good
- +1 = very good
- +1½ = excellent

Scoring will be on the basis of 60 to 80, with 70 representing an average performance.

The following will result in a no score or disqualification from the class:

- Failure to complete the pattern as written.
- Equipment failure that delays completion of the pattern.
- Performing maneuvers other than in the specified order.

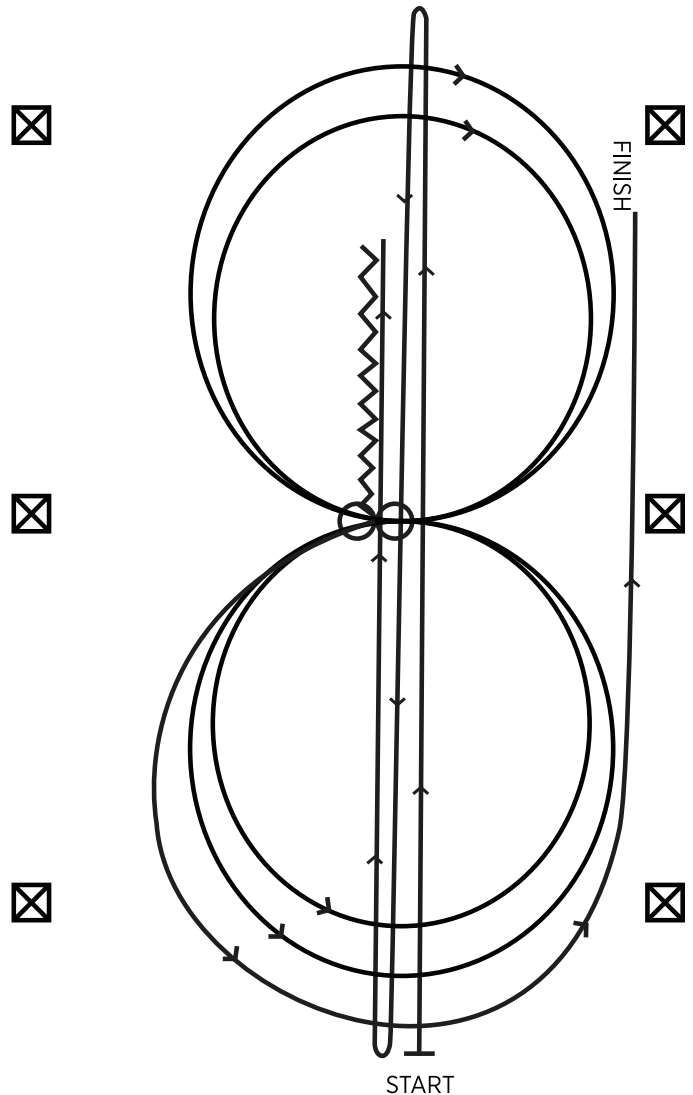

Figure 19. Reining pattern 1.

- Including maneuvers not specified, including but not limited to backing more than two strides (two strides meaning four steps with the front feet).
- A turn of more than 90 degrees where one is not specified.
- Running away or failure to guide where it becomes impossible to discern whether the entry is on pattern.
- Jogging in excess of one-half circle or one-half the arena while starting a circle, circling or exiting a rollback.
- Overspins of more than ¼-turn.
- Use of illegal equipment.
- Willful abuse of the horse.
- Using the reins or romal as a whip.

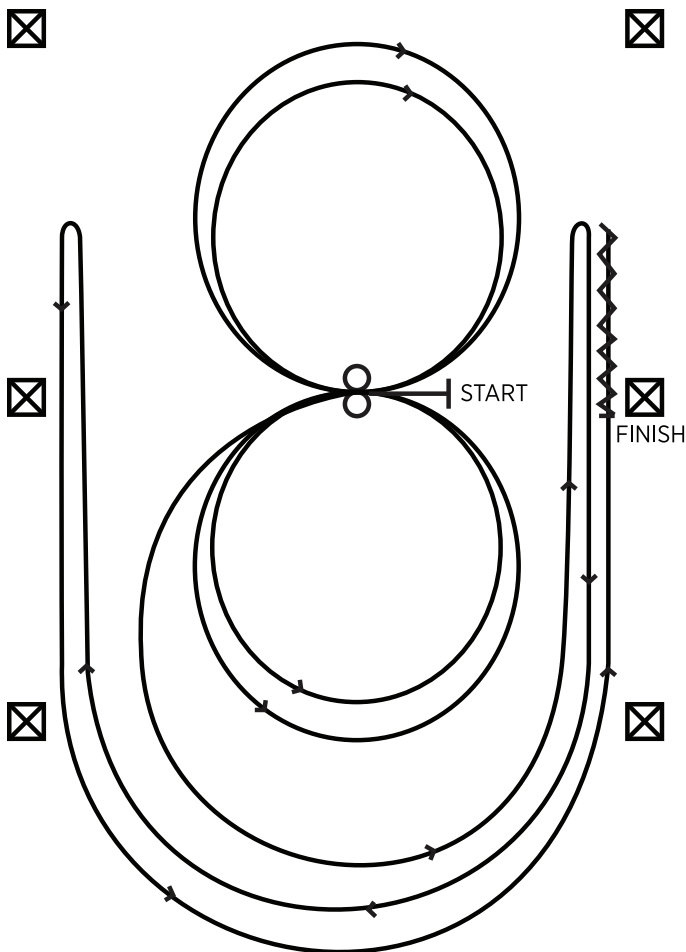

Figure 20. Reining pattern 2.

- Using more than one finger between reins.
- Changing hands on the reins.
- Using two hands on the reins (except with junior horses that are ridden two-handed, or that are shown in a bosal or snaffle bit).
- Fall to the ground by horse or rider.
- Balking or refusing a command.

**The following will result in a 5-point reduction:**

- Spurring in front of the cinch.
- Use of the free hand to instill fear.
- Holding the saddle or touching the horse with the free hand.
- Blatant disobedience of the horse, including kicking, biting, bucking and rearing.

**The following will result in a 2-point reduction:**

- Failure to go beyond markers on stops or rollbacks when it is called for in the pattern.
- Break of gait.
- Freeze up in spin or rollbacks.
- On walk-in patterns, failure to stop or walk before executing a canter departure.
- On run-in patterns, failure to be in a canter before the first marker.

Starting or performing circles out of lead will be judged as follows: Each time a horse is out of lead, a judge is required to deduct 1 point, which is cumulative. The judge will deduct 1 point for each quarter of the circumference of the circle or any part thereof that the horse is out of lead. The judge is required to deduct ½ point for a delayed change of lead by one stride.

**Other faults and their penalties include:**

- Starting a circle at a jog or exiting rollbacks at a jog up to two strides (½ point)
- Over- or under-spinning up to one-eighth of a turn (½ point)
- Failure to remain a minimum of 20 feet from the wall or fence when approaching a stop or rollback (½ point)
- Over- or under-spinning from one-eighth to one-quarter turn (1 point)
- Jogging beyond two strides, but less than one-half circle or one-half the length of the arena (2 points)

When a change of lead is specified immediately before a run at the end of the arena, failure to change leads will be penalized as follows:

- Failure to change leads by one stride (½ point)
- Failure to change leads beyond one stride but completed before the next maneuver (1 point)

## REINING DIVISION

- In patterns requiring a run-around, failure to be on the correct lead when rounding the end of the arena (1 point)
- Lead is not changed before next maneuver (2 points)
- Failure to end on the correct lead pivot to the center point of the arena (2 points)

### **Faults against the horse to be scored at the judge's discretion, but not to cause disqualification:**

- Opening mouth excessively (when the horse is shown in a bit).
- Excessive jawing, opening mouth or head raising on stop.
- Lack of smooth, straight stop on haunches, bouncing or sideways stop.
- Refusing to change leads.
- Anticipating signals.
- Stumbling
- Backing sideways.
- Knocking over markers.

### **Faults against the rider to be scored accordingly, but not to cause disqualification:**

- Losing a stirrup.
- Any unnecessary aid given by the rider such as talking, petting, spurring, quiring or jerking of reins)
- Failure to go beyond markers on rollbacks and stops is considered a fault. Failure to run circles or figures eights within the markers is not considered a fault, depending on arena conditions and size.

## ENGLISH/WESTERN DIVISION

# English/Western Division

## Lead Line Equitation

Lead Line Equitation Criteria	Points
Rider's performance, & appointments of horse, rider & handler.....	90
Horse's performance .....	10
<b>Total .....</b>	<b>100</b>

### Criteria Explanation

**RIDER'S PERFORMANCE** – This class is recommended for 4-H cloverbud or inexperienced riders. Horses may be shown either English or western. The riders will be judged on equitation at the walk both ways of the ring and must have both feet in the stirrups at all times. It is highly recommended that a halter be used in addition to the bridle, and that the lead be attached to the halter and not the bridle. The handlers may assist the rider but shouldn't have sole control of the horse. In the lineup, the rider (**not the handler**) should back the horse.

**APPOINTMENTS OF HORSE, RIDER & HANDLER** – Appointments of horse and rider should be consistent with the seat chosen, as described in this book. Handler's appointments should be appropriate for the horse and rider's appointments.

## Walk-Trot Equitation

Walk-Trot Equitation Criteria	Points
Rider's performance, & appointments of horse & rider.....	90
Horse's performance .....	10
<b>Total .....</b>	<b>100</b>

### Criteria Explanation

**RIDER'S PERFORMANCE** – This class is recommended for young or inexperienced riders. Horses may be shown either English or western, and riders must have correct appointments for the chosen seat, as described in this book. The riders will be judged on equitation at the walk and jog, trot or second gait, both ways of the ring. Riders' feet must be in the stirrups at all times. The horse should be suitable to the rider's ability. The rider should be in control of the horse at all times.

**APPOINTMENTS OF HORSE AND RIDER** – Appointments of horse and rider should be consistent with the seat chosen, as described in this book.

## English/Western Trail Class

### Appointments of Horse

**APPOINTMENTS OF HORSE AND RIDER** – The appointments of the horse and rider should be consistent with the seat chosen (such as western, saddle seat, hunter seat or dressage) and must match. See the appropriate divisions for details on appointments. This class may not be performed bareback.

### Horse's Performance & Manners

This class will be judged on the performance of the horse over the obstacles, with emphasis on manners, response to the rider and attitude. Credit will be given to exhibitors negotiating the obstacles with style, expression and some degree of speed, providing carefulness is not sacrificed. Credit will be given to horses showing the ability to pick their own way through courses when obstacles warrant it and willingness to respond to rider's cues on more difficult obstacles.

Horses shall be penalized for any unnecessary delay while approaching the obstacles. Horses with artificial appearance over obstacles should be penalized, as should riders who stand in the stirrups and lean forward over the horse's neck in an exaggerated manner.

No horse that deviates from the posted pattern in any way or that receives a "no score" for a particular obstacle shall place above any horse that completes the pattern as written.

### Course Description

#### **Safety is extremely important when designing a trail class.**

Obstacles should simulate situations that are naturally encountered on the trail, not situations that are designed to trap or eliminate exhibitors. It is recommended that trail classes be held in an arena or roped off area, if possible.

Courses shall include a minimum of six and a maximum of eight obstacles. Three of the obstacles should come from the "mandatory obstacles" list and the remainder from the "optional obstacles" list. The obstacles should remain constant throughout the class.

After the obstacles have been placed on a course, it is recommended that the setup crew use marking chalk, flour or another safe material under the objects to indicate where they should be reset if a horse moves them while negotiating the course. The course must be returned to its original design after each horse has worked.

Horses shall not be required to work on the rail. Courses will be designed to require exhibitors to show their horses' three gaits (depending on the breed) for the judge to evaluate:

- Walk
- Jog, trot or second gait – at least 30 feet

- Lope, canter or third gait – at least 50 feet

**Note:** Trail courses for walk-trot riders must be adjusted so that exhibitors are not required to lope or canter.

When measuring distances and spaces between obstacles, the measurement should be taken from the inside base of one obstacle to the inside base of the next along the typical path of the horse.

The judge must walk the course and has the right and duty to alter the course in any manner to remove or change any obstacle he or she deems unsafe or nonnegotiable. If at any time the judge deems a trail obstacle unsafe, it shall be repaired or removed. If the obstacle can't be repaired and exhibitors have already completed the course, the score for that obstacle shall be deducted from the scores of exhibitors who have completed the course and the obstacle removed.

When possible, the trail course should be posted at least 60 minutes before the scheduled time of the class.

#### **Mandatory obstacles (choose three):**

- Sidepass
- Ride over at least four logs or poles placed on the ground. The logs can be placed in a straight line, curved, zigzag or a combination. The recommended spacing between the logs follows:
  - Walk-overs – 20 inches to 24 inches
  - Trot-overs – 3 feet to 3 feet, 6 inches, or increments thereof
  - Lope-overs – 6 feet to 7 feet, or increments thereof

• Ride over wooden bridge. Bridge must be at least 36 inches wide and at least 6 feet long, and must be sturdy, safe, and negotiated at a walk.

• Open, pass through and close a gate. Course instructions should designate whether gate is to be negotiated as a right-hand push or pull or a left-hand push or pull, and the gate must be set up accordingly. The gate must not endanger horse or rider. If a rope gate is used, the rider must never flip the rope over the horse's head or change hands on the rope.

#### **Optional obstacles (choose three to five, depending on how many mandatory obstacles are chosen):**

- Back through a path built with cones spaced a minimum of 28 inches apart or rails spaced a minimum of 36 inches apart. Neither cones nor rails may be elevated, and horses may **not** be required to back over objects.
- Carry an object from one part of the arena to another. Objects may only be those that might reasonably be carried on a trail ride, such as a coat or slicker or a bucket.
- Put on and take off a slicker.



- Open and close a mailbox. Showing an object taken from inside the mailbox is optional.
- Enter, turn inside and exit from a box. This obstacle shall consist of four logs or rails, each 5 feet to 8 feet long, laid in a square. Exhibitors will enter the square by riding over the designated log. When all four of the horse's hooves are inside the square, the rider executes the turn indicated and leaves the box.
- Any other safe and negotiable obstacle that riders could reasonably expect to encounter on a trail that the judge approves. Such obstacles may not be on the "prohibited obstacles" list.
- Dismount. May only be used as the last obstacle of the course.

**Prohibited obstacles include the following:**

- Tires
- Animals
- Animal hides
- PVC pipe
- Jumps higher than 12 inches
- Rocking or moving bridge
- Water box with floating or moving parts
- Flames, dry ice, fire extinguishers and similar devices
- Logs or poles elevated in a way that allows them to roll
- Firearms, whether real or toy

**Scoring Guidelines**

Sample scoresheets for this class are online at:

- **American Quarter Horse Association Resources** [aqha.com/Resources/](http://aqha.com/Resources/) – Scroll down to "Scoresheets."
- **Appaloosa Horse Club Downloadable Forms** [appaloosa.com/downloadable-forms.htm](http://appaloosa.com/downloadable-forms.htm) – Scroll down to "Judges Score Sheets."

Riders may use only one hand on the reins, except when riding junior horses with snaffle bits or bosals, and when riding an English style. Riders may not change hands on the reins when the horse is in motion. Riders may change hands on the reins when working with an obstacle (such as a gate or mailbox). English riders are permitted to put both reins in one hand when negotiating an obstacle (such as a gate or mailbox). Riders are permitted to put one finger between reins. Rider's hands must be clear of the horse and saddle while the horse is in motion.

**Obstacle Scores**

Each obstacle should be assigned an obstacle score on this scale:

+ 1 1/2 points = excellent

- + 1 point = very good
- + 1/2 point = good
- 0 points = correct
- 1/2 point = poor
- 1 point = very poor
- 1 1/2 points = extremely poor

Obstacle scores are to be determined and assessed independently of penalty points.

**Penalty Scores**

Penalties should be assessed for each occurrence as follows.

**Disqualification from the class:**

- Using more than one finger between the reins.
- Using two hands on the reins, except for exhibitors riding junior horses in a snaffle bit or romal or riding an English style.
- Changing hands on the reins (except when necessary to negotiate an obstacle; English riders are permitted to put both reins in one hand to negotiate an obstacle).
- Using a romal other than for reining the horse.
- Equipment failure that delays completion of the pattern.
- Touching the horse on the neck to lower the head.
- Using the free hand to instill fear or to praise.
- Falling to the ground (horse or rider).
- Riding outside the designated course boundaries.
- Willfully abusing the horse.
- Rearing, bucking or other major disobedience by the horse.
- Performing the class with mismatched equipment and attire.
- Performing the class bareback.
- Breaking the pattern (going off course).

**1/2-point penalty:**

- Each tick of a log, pole, cone or obstacle.

**1-point penalty:**

- Hitting or stepping on a log, pole, cone or obstacle (each occurrence).
- Breaking gait at a walk or jog for two strides or less.
- Placing both front or hind feet in a single-stride slot or space.
- Skipping over or failing to step into a required space.
- Splitting pole, or having the pole between two front or hind feet, in a lope-over.

**3-point penalty:**

- Breaking gait at a walk or jog for more than two strides.
- Going out of lead or breaking gait at a lope, canter or third gait (except when correcting an incorrect lead).
- Knocking down an elevated pole (such as a jump 12 inches high or less), cone, barrel or plant obstacle, or severely disturbing an obstacle.
- Stepping outside the confines of, falling or jumping off an obstacle (such as a back-through grid, bridge, sidepass, box or water box) with one foot. Each foot will accrue additional penalties.

**5-point penalty:**

- Dropping a slicker or other object that is required to be carried on the course.
- Refusing, balking or attempting to evade an obstacle by shying or backing (first time).
- Losing control or letting go of a gate.

**5 or more penalty points:**

- Failing to ever demonstrate a correct lead or gait, if designated.
- Failing to complete an obstacle (for example, open the gate, pass through the gate and close the gate).
- Refusing, balking or attempting to evade an obstacle by shying or backing (second time).

**No score (for a particular obstacle only):**

- Negotiating an obstacle differently than is described on the pattern.
- Missing or not attempting an obstacle.
- Refusing, balking or attempting to evade an obstacle by shying or backing (third time).

## English/Western Riding Class

[English/western] riding is an event where the horse is judged on quality of gaits, lead changes at the lope or canter, response to the rider, manners and disposition. The horse should perform with reasonable speed, and be sensible, well-mannered, free and easy moving. (*AQHA Handbook of Rules and Regulations*)

**HORSE'S PERFORMANCE AND MANNERS** – Horses will be judged on the riding quality of gaits, changes of leads, response to the rider, manners and disposition. Preference will be given to complete flying changes of leads midway between the markers throughout the entire class. This indicates the control of a rider over his or her mount and encourages youth to train for the event.

A rider will be penalized for losing a stirrup, using two hands on the reins (except where two hands are permitted), changing hands on the reins (except when negotiating the gate) or touching any part of the

saddle with the free hand. While the horse is in motion, the rider's hands should be clear of the horse and saddle.

**APPOINTMENTS OF HORSE** – Appointments of horse and rider should be consistent with the seat chosen, as described elsewhere in this book. Skid boots, splint boots and protective leg wraps are optional in English/western riding classes.

**APPOINTMENTS OF RIDER** – Appointments of horse and rider should be consistent with the seat chosen, as described in this book.

## Course Description

Figure 21 illustrates the English/western riding course. The American Quarter Horse Association (AQHA) western riding pattern 2 is also acceptable; however, if it is to be used, copies of the pattern should be provided to judges and exhibitors well in advance of the class. The use of the gate is recommended but optional, at the discretion of the local show committee and according to local conditions. The short, double line on the pattern represents a swinging gate that the horse, on entering the arena, must put the rider in a position to open, pass through and close without dismounting. The gate may be located in any convenient part of the arena where it will not interfere with the balance of the routine. Care should be exercised in selecting a gate that will not endanger the horse or rider.

The eight small dots represent markers (barrels, kegs or cones are recommended). These should be separated by a uniform distance of not less than 30 feet and no more than 50 feet. The distances may be altered if the local arena is too small.

1. The horse will be judged on quality of gaits, changes of lead, response to the rider, manners, disposition and intelligence.

2. The horse should maintain an even cadence and change leads precisely and easily, front and rear, at the center point between markers as indicated by the shaded areas on the pattern. The horse should have a relaxed head carriage showing its response to the rider's hands, with moderate flexion at the poll. The tail should remain quiet throughout the pattern. The horse should cross the log at the jog or pleasure gait and lope without breaking gait or radically changing stride.

3. Additional information about the pattern follows.

- The arrows on the lines indicate the direction of travel and the type of line indicates the gait.
- The log should be at least 8 feet long and laid on the ground.
- The markers should be pylons. In the row of five markers, the markers are separated by equal distances of 30 to 50 feet. The markers in the row of three are aligned with the first, third and fifth markers in the row of five.

• After stopping and backing at least 10 feet at the end of the pattern, the rider will report to the judge to be excused.

4. A horse going off pattern is disqualified. Off pattern is any of the following: an incomplete pattern, incorrect order of maneuvers, knocking over markers, passing on the wrong side of markers, making extra loops in the pattern, missing the log, five or more simple lead changes, and failure to change leads.

5. The judge may require an exhibitor to repeat or reverse any part of the routine.

6. Only one hand is allowed on the reins and only the index finger is allowed between the reins. Except when negotiating the gate, the hand on the rein cannot be changed. When romal reins are used they will be carried as described under "Stock Seat Equitation" in the Western Division.

7. The running walk or other pleasure gait is acceptable for any horses that do not jog.

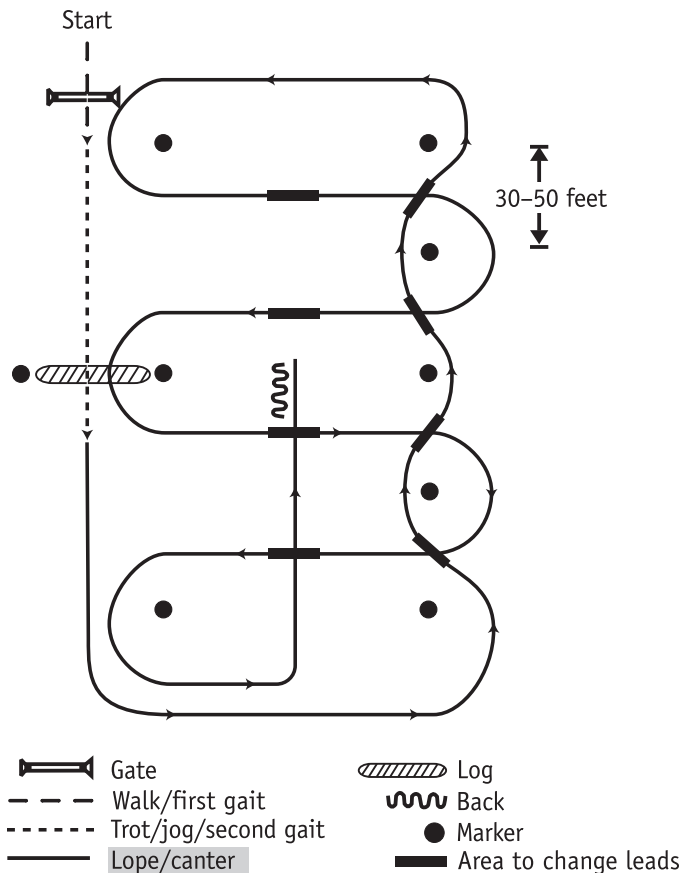

Figure 21. English/western riding pattern.

8. Each rider will enter the ring with a score of 70, which represents an average performance. Final scores will generally fall in a range from 40 to 80 points.

• **Scoring guidelines:** Points will be added or subtracted from the eight maneuvers on the following basis.

-1 = very poor

-1/2 = poor

0 = average

+1/2 = good

+1 = excellent

• Sample scoresheets are available online from:

- American Quarter Horse Association Resources at [aqha.com/Resources](http://aqha.com/Resources) – Scroll down to the "Score Sheets" section.

- Appaloosa Horse Club Downloadable Forms at [appaloosa.com/downloadable-forms.htm](http://appaloosa.com/downloadable-forms.htm) – Scroll down to "Judges Score Sheets" section.

• The eight maneuvers are:

- a. Gate (recommended but optional)
  - b. Trot over the log
  - c. Trot and transition to lope
  - d. Line (side) lead changes (plus or minus 1 point per change)
  - e. First two crossing lead changes (plus or minus 1 point per change)
  - f. Lope over the log
  - g. Second two crossing lead changes (plus or minus 1 point per change)
  - h. Lope, stop and back a minimum of 10 feet
- An additional score of plus or minus 1 point will be given for pattern accuracy and smoothness.

• Contestants will be penalized as follows:

**5 points**

- Releasing the gate due to the horse's disobedience, knocking over or being unable to complete gate
- Failure to change leads where indicated in pattern

**3 to 5 points**

- Using the free hand to instill fear in the horse

**3 points**

- Breaking gait at a lope, including a simple lead change
- Making extra lead changes anywhere on the course

- Breaking gait at a walk or jog for two or more strides
- Failure to begin lope within 30 feet after crossing log

**2 points**

- Failing to take a prescribed gait at the designated point in the pattern

- Failing to change lead behind until the next change point

**1 point**

- Breaking gait at a walk or trot up to two strides

- Hitting the log

**½ point**

- Touching the log lightly
- Failing to change lead behind from one-half stride up to a cone

**Disqualifications** – Failure to perform at least four flying lead changes will result in disqualification.

• The following are considered faults and should be penalized at the judge’s discretion:

- Opening mouth excessively or throwing head on maneuvers
- Anticipating signals or early lead changes
- Stumbling
- Losing a stirrup or holding on
- Any unnecessary aid given by the rider, such as talking, petting, spurring, quirting or jerking the reins

# Driving Division

## Reinsmanship (Driving Equitation)

**APPOINTMENTS OF HORSE** – The horse is to be shown in a harness suitable to the vehicle used. The pleasure driving harness is traditionally black leather with square, patent leather blinkers, snaffle bridle, overhead check and running martingale. Brass, chrome or hard rubber hardware is acceptable. A whip is optional.

**VEHICLE** – The vehicle should be an appropriate two- or four-wheeled vehicle with wire or wood wheels and in sound condition. Driver should strive to present an appropriate turnout. “Appropriate” indicates the balance and pleasing appearance of the combination of horse and vehicle. Factors determining the above include compatible size, type and weight of horse and vehicle. The way of going of the horse may also affect the overall appearance, that is, a high action horse is more suitable for a formal vehicle. A low going, ground covering horse presents a more pleasing appearance for a road or country type vehicle.

**APPOINTMENTS OF DRIVER AND ATTENDANT (HEADER)** – Drivers and attendants should be dressed conservatively, according to the style of the present day. Any attempt to introduce period costumes or gaudy trappings is discouraged. Dress for the driver should conform to the type of turnout (that is, formal, park, country or sporting) and should always be neat and clean. Suggested attire for gentleman is dress pants and shirt, coat or jacket, tie, boots, and hat or protective headgear. Suggested attire for ladies is a dress, tailored suit, skirt or slacks and blouse, vest or jacket, and boots. Hats are optional for ladies. Gloves and aprons or lap robes are optional. Attendants should wear long pants, shirts with collars and boots.

**GENERAL COMMENTS** – Attendants are optional.

Reinsmanship Criteria	Points
Driver’s performance (handling of reins & whip, control, posture, & overall appearance) .....	75
Appointments of horse, driver & attendant (condition & fit of harness & vehicle, & neatness of attire).....	25
<b>Total .....</b>	<b>100</b>

### Criteria Explanation

**DRIVER’S PERFORMANCE** – The driver should be seated comfortably on the box so as to be relaxed and effective. The elbows and arms should be close to the body with an allowing, but steady hand enabling a consistent feel with the horse’s mouth. An allowing, but

steady hand permits the horse to move forward, but maintains steady contact on the horse's mouth to facilitate cuing.

**Class Routine**

Horses enter the ring to the right at a normal trot. All gaits will be performed in both directions of the ring. In a lineup, horses must stand quietly (square or parked), stay checked at all times and back readily. Attendants are permitted to assist in lining up the horses, wiping the horses, checking the reins and overcheck, and giving other assistance to ensure driver safety. The attendant should step back as the judge approaches.

The gaits called for are:

**Walk** – Flat, four-beat and brisk.

**Normal or Working Trot** – A two-beat gait to be performed at medium speed with moderate collection. The trot should be mannerly, cadenced, balanced and free moving.

**Extended or Strong Trot** – A two-beat gait that is stronger and faster than the normal trot, performed with a lengthened stride. Each animal should reach the extended trot in harmony with its own maximum natural stride, showing moderate collection. The extended trot must be mannerly, cadenced, balanced and free moving.

**Reverse** – Drivers may use a large S turn or cross on the diagonal.

**🐾 Pleasure Driving**

Pleasure Driving Criteria	Points
Performance, manners & way of going of horse .....	70
Condition & fit of harness & vehicle.....	20
Appointments of horse, driver & attendant (header).....	10
<b>Total</b> .....	<b>100</b>

**Criteria Explanation**

**PERFORMANCE, MANNERS AND WAY OF GOING OF HORSE** – To be judged on manners, suitability, performance, quality, presence and apparent ability to give a good pleasure drive.

**CONDITION AND FIT OF HARNESS AND VEHICLE** – See vehicle specifications for “Reinsmanship.”

**APPOINTMENTS OF HORSE, DRIVER AND ATTENDANT (HEADER)** – See appointments for “Reinsmanship.”

**GENERAL COMMENTS** – Attendants are optional.

**Class Routine**

Horses enter the ring to the right at a normal trot. All gaits will be performed in both directions of the ring. In the lineup, horses must stand

quietly (square or parked), stay checked at all times and back readily. Attendants are permitted to assist in lining up the horses, wiping the horses, checking the reins and overcheck, and giving other assistance to ensure driver safety. The attendant should step back as the judge approaches.

The gaits called for are:

**Walk** – Flat, four-beat and brisk.

**Normal or Working Trot** – A two-beat gait to be performed at medium speed with moderate collection. The trot should be mannerly, cadenced, balanced and free moving.

**Extended or Strong Trot** – A two-beat gait that is stronger and faster than the normal trot, performed with a lengthened stride. Each animal should reach the extended trot in harmony with its own maximum natural stride, showing moderate collection. The extended trot must be mannerly, cadenced, balanced and free moving.

**Reverse** – Drivers may use a large S turn or cross on the diagonal.

**🐾 Fine Harness Horse**

Fine Harness Horse Criteria	Points
Manners, suitability, quality and performance of horse .....	70
Condition and fit of harness and vehicle.....	20
Appointments of driver and attendant (header).....	10
<b>Total</b> .....	<b>100</b>

**Criteria Explanation**

**MANNERS, SUITABILITY, QUALITY AND PERFORMANCE OF HORSE** – The horse is to be judged on manners, suitability, performance, quality and presence.

**CONDITION AND FIT OF HARNESS AND VEHICLE** – The horse is to be shown in a harness suitable to the vehicle used. The traditional fine harness is black leather with patent leather trim. Reins and traces should be round; reins are russet. Hardware should be brass, but black rubber covered buckles are acceptable. A snaffle bridle with overhead check, square blinkers and a running martingale is conventional; however, an acceptable alternative is a side check bridle. This bridle has round blinkers, a liverpool or Buxton bit, and a jointed check bit. No martingale is allowed with a liverpool or Buxton bit. Horses should be bitted in the ring or half-cheek. A whip and handholds are optional. Horses are to be shown in a four-wheeled show buggy with wire wheels and without a top, in sound condition.

**APPOINTMENTS OF DRIVER AND ATTENDANT (HEADER)** – See appointments for “Reinsmanship.”

**GENERAL COMMENTS** – Attendant (header) is required in the lineup.

**Class Routine**

Horses enter the ring to the right at a park trot. All gaits will be performed in both directions of the ring. In a lineup, the horse must stand quietly (square or parked) and stay checked at all times. Attendants are permitted to assist in lining up the horses, wiping the horses, checking the reins and overcheck, and giving other assistance to ensure driver safety. The attendant should step back as the judge approaches.

The gaits called for are:

**Park Walk** – Performed with great style, collection, elegance and airiness of motion. In its preferred form, however, it is still a true walk with a four-beat cadence, although a two-beat cadence may be acceptable. It should be snappy, collected, animated, elastic and on a straight line.

**Park Trot** – A lofty, diagonal two-beat gait with emphasis on enhanced natural action and precise cadence. The trot should be executed so that the flight of the foot approaches the arc of a circle. The action and stride should be of a height and length that can be performed with rapidity, elasticity and precision, and continued consistently all the way around the ring. Considerable shoulder movement is desired, and rear action should be balanced with front. The overall graceful appearance of the horse in motion is more important than any single component – such as height of action – alone.

**Show Your Horse** – At the judge’s discretion in an open class, the exhibitors may be asked to “show your horse” to its best advantage. Some increase or decrease in speed is permitted, but not required, and excessive speed should be penalized.

**Reverse** – Drivers may use a large S turn or cross on the diagonal.

**Roadster to Bike**

Roadster to Bike Criteria	Points
Performance, speed, quality & manners of horse .....	70
Condition & fit of harness & vehicle.....	20
Appointments of driver.....	10
<b>Total .....</b>	<b>100</b>

**Criteria Explanation**

**PERFORMANCE, SPEED, QUALITY AND MANNERS OF HORSE** – Horses should be shown on the rail at all times except when passing, and should go to the far end of every corner without side reining. They should be light mouthed, capable of being taken up at any time, and be willing to walk and stand while being judged in the lineup.

**CONDITION AND FIT OF HARNESS AND VEHICLE** – The appropriate harness includes blinkers of square pattern, snaffle bit, overhead check and running martingale. Quarter boots or bell boots are allowed. A whip is optional. Horses are to be shown in a road bike with stirrups but without a boot or basket.

**APPOINTMENTS OF DRIVER** – Driver should wear stable colors, cap and jacket to match. Protective headgear of any color is acceptable and encouraged.

**Class Routine**

Roadsters enter the ring clockwise at a jog-trot; show at a road gait; turn counterclockwise at a jog-trot, show at a road gait and then trot at speed. The gaits called for are the jog-trot, road gait and full speed. The judge may ask roadsters to walk.

**Gait Requirements** – The principal gait assignment for roadsters is the trot. They will be asked to trot at three different speeds; the slow jog-trot, the fast road gait and at full speed. Judges may ask a roadster to walk. Judges are encouraged to emphasize that roadsters are to be shown at three distinct speeds. Exhibitors executing gaits not called for should be penalized.

**Reverse** – Drivers may use a large S turn or cross on the diagonal.

## Gymkhana Division

All gymkhana equipment will be required.

**APPOINTMENTS OF HORSE (WESTERN)** – A standard western-type saddle must be used. The western saddle may have a slick or a swelled fork, with or without a horn, and either a high or low cantle. A rope or reata is prohibited. Use of any standard bit or conventional hackamore is optional. However, the judge may prohibit the use of bits or equipment he or she considers severe. If someone other than the judge is checking equipment, that individual may make suggestions to the judge regarding severe equipment; however, the judge makes the final decision. Running martingales, standing martingales or tiedowns are permitted. Bell boots, shin boots or skid boots are permitted. If split reins are used, they must be tied or fastened together. A single rein is recommended.

**APPOINTMENTS OF HORSE (ENGLISH)** – Snaffles – with or without dropped nosebands, pelhams, kimberwicks and full bridles – are acceptable. A running martingale is permitted, as are standing martingales or tiedowns. McClellan or similar saddles are considered western when western bridles are used and English when English bridles are used. Any other type of English saddle is acceptable.

**APPOINTMENTS OF RIDER** – The rider's appointments may be either English or western (as described in the Fitting and Showing Division of this book) depending on the tack being used, but cannot be a combination of both. Riders must wear protective headgear throughout the class (see General Rule 3). If any appointments violate the rules, the rider will be permitted to make the necessary corrections during the time from the appointments check until the last entry has competed in that class. If the rider fails for any reason to make the necessary corrections or does not appear at the gate by the time the last entry has competed, he or she will be disqualified from that class. Once a competitor has been allowed to ride, he or she will not be disqualified because of the appointments and tack unless they have been altered. Spurs (rowelled and unrowelled) and bats are optional but must not harm the horse. Protective equipment for the rider (such as shin guards) may be used.

### General Gymkhana Rules

1. All gymkhana events will be timed.
2. Horsemanship and sportsmanship will be stressed.
3. Judges' decisions will be final.
4. The use of spurs, bats or over-and-under bats is optional. Excessive or abusive use of these items may be penalized. Any unsportsmanlike behavior (such as arguing, yelling, hooting at the judge or show man-

agement) by contestants, volunteer leaders or family members – in or out of the arena – will result in disqualification.

5. Horses must be under control at all times.
6. There will be a 5-second penalty for knocking over pattern markers.
7. Horses must be mounted when entering the ring. No assistance to either horse or rider is permitted past the arena gate.
8. After completing the course a rider **must** dismount and lead the animal from the arena. Failure to do so will result in disqualification. Mounted riders should stay clear of the exit gate to allow the dismounted rider to safely exit the arena.

**Disqualifications** – Any of the following infractions will disqualify an entry.

- Running through the chute or gate to enter the arena.
- Failure to begin the course within 1 minute after the ready signal is given.
- Failure of the rider to enter the arena mounted.
- A stop or willful refusal to move forward.
- Riding the horse out of the arena.
- Loss of course, which includes negotiating obstacles in other than the specified order or in the wrong direction. This includes circling, backing or reversing the direction of movement.
- Horse behaving in an unruly manner or out of control.
- Any kind of cruelty to the horse whether or not specifically mentioned in these rules, will disqualify the competitor.
- Spurring, striking or beating the horse in any manner whatsoever forward of the cinch after entering the arena. Touching the horse will not be considered striking or beating the horse.
- Fall of horse or rider while in the arena.
- Using rubber bands or other items to secure any part of the rider to any part of the horse or tack.

**Timing Procedure** – Electric timers are preferred over stopwatches. If an electric timer is used, at least one official should take the time using a stopwatch in case the electric timer fails. If an electric timer is not available, three stopwatches will be used. The median time of the three readings will be the official time. (The median time is the time indicated by two of the three stopwatches if two agree. If no two watches agree, the median time is the time indicated by the watch which indicated neither the fastest nor the slowest time.) All stopwatches must be calibrated to at least one-tenth of a second.

- The start/finish timing line must be a minimum of 30 feet from the end of the arena.

- The timing line must be visibly marked in the arena.
- Contestants are allowed running starts.

**GYMKHANA CLASSES**

**Barrel Bending**

The barrel bending pattern is run around six barrels. The barrels are placed in a straight line running perpendicular to the starting line and 24 feet apart from center to center. The first barrel is set 25 feet from the starting line. The barrels will be plastic 5-gallon containers with approximately 15 pounds of sand in each one.

Contestants may start on either side of the line of barrels. They will start at barrel one (see fig. 22) and bend in and out of all the barrels down and back. Jumping a barrel with either or both front or both hind legs will result in a 5-second penalty. Skipping a barrel will result in disqualification. Knocking over a barrel will result in a 5-second penalty. The judge will stand in line with the markers at the end of the row of barrels.

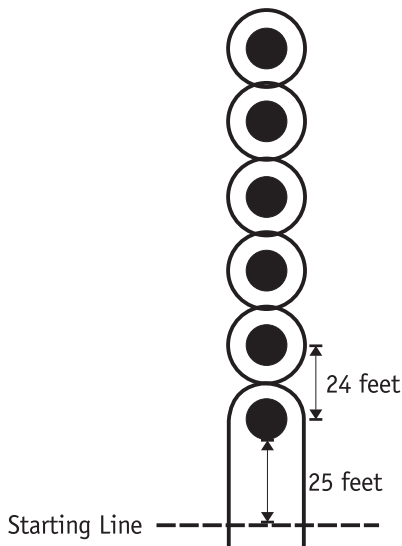

Figure 22. Barrel bending course.

**Cloverleaf Barrel Race**

Barrels should be the size of a 55-gallon drum, with no sharp edges. Each barrel should be painted so that it can be easily distinguished from the background. Protective devices around steel barrel tops are required.

The size of the pattern (see fig. 23) should be 105 feet (35 yards) between barrels 1 and 2, 120 feet (40 yards) between barrels 2 and 3, 120 feet (40 yards) between barrels 1 and 3, and 75 feet (25 yards) from the timer to the first barrel. The course must be measured exactly.

If the course is too large for the available space, then each measurement of the pattern should be reduced 15 feet (3 yards) from the fence. If the course specified in this rule book is too big for the available space, the distance from barrel 3 to the finish line need not be reduced 15 feet at a time, as long as there is enough room for the horse to stop safely.

Riders have the option of riding course A or B.

**Course A** – The entry must cross the timing line, circle barrel 1 clockwise, circle barrel 2 counterclockwise, circle barrel 3 counterclockwise and run between barrels 2 and 3 to cross the timing line.

**Course B** – The entry must cross the timing line, circle barrel 2 counterclockwise, circle barrel 1 clockwise, circle barrel 3 clockwise and run between barrels 2 and 3 to cross the timing line.

A 5-second penalty will be assessed for each barrel knocked down.

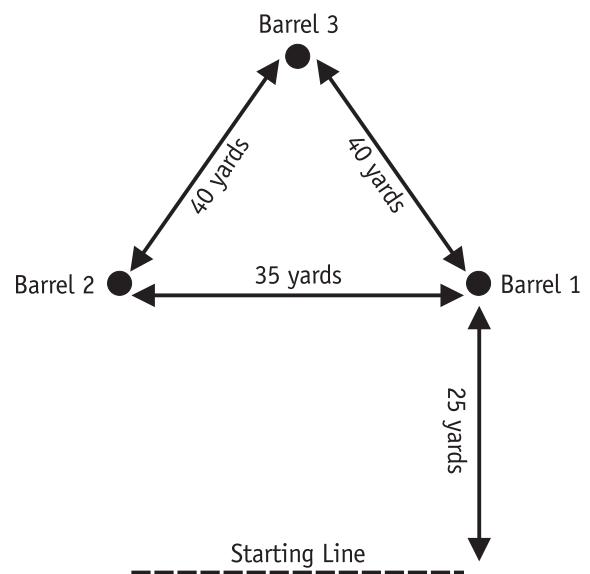

Figure 23. Cloverleaf barrel race (patterns A and B).



## Indiana Flag Race

The course (see fig. 24) is set up in the same manner as for the Cloverleaf Barrel Race. Two 5-gallon buckets filled with approximately 4 inches of sand should be placed on the centers of the 1st and 3rd barrels. The length of the flag sticks should be 12 inches to 16 inches above the edge of the bucket. Wooden doweling 3/4 inch in diameter, or other round suitable material, should be used for the flag.

The rider will pick up a flag at 1, ride behind 2 and place the flag in the bucket at barrel 3. Riders have the option of riding course A or B:

**Course A** – The entry will cross the starting line and begin following the pattern to the left.

**Course B** – The entry will cross the starting line and begin following the pattern to the right.

**Disqualifications** – Causes of disqualification include:

- Failing to pick up the flag on the first pass.
- Failing to place the flag in the bucket on the first pass.
- Hitting any part of the horse with the flag or stick.
- Dropping the flag.
- Knocking over any of the barrels or knocking the bucket off, or over, on the barrel.
- Dropping the flag into the bucket with the flag end down.

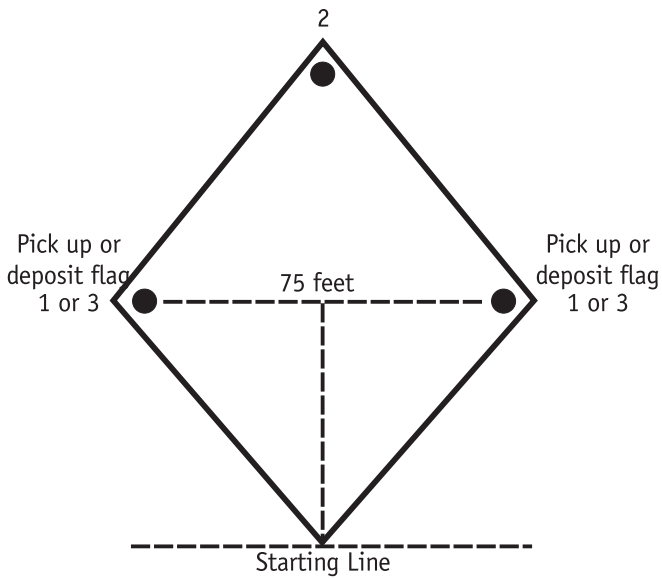

Figure 24. Indiana flag race course.

## Keyhole

The course will be laid out with a limed keyhole on the ground with the opening of the keyhole facing the starting line (see fig. 25). The center of the circle should be 100 feet from the timing line. The keyhole will be in the form of a broken circle 22 feet in diameter with a throat 5 feet wide. The angled sides are 5 feet long. The horse will cross the timing line, enter the circle of the keyhole, turn around (in either direction) entirely within the circle of the keyhole, and recross the timing line.

**Disqualification** – Causes of disqualification include:

- The horse stepping over the chalk line at any point.
- The horse turning around in the throat of the keyhole rather than in the circle.
- Failing to complete the pattern.
- Failing to start or finish between the two markers.

PATTERN 1

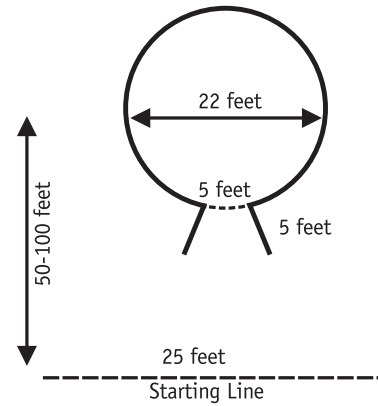

PATTERN 2

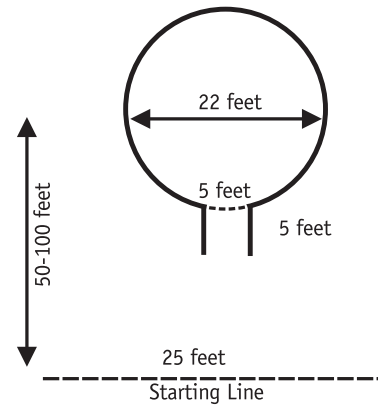

Figure 25. Keyhole race course.

## Pole Bending

The pole bending pattern (see fig. 26) is run around six poles. The poles are placed in a straight line 21 feet apart, going away from the starting line. The first pole is to be 21 feet from the starting line. Poles are 6 feet high and set on top of the ground, with bases 10 inches to 14 inches in diameter.

Contestants may start on either side of the line of poles. They will cross the starting line, move in an approximately straight line to pole 6 (the farthest pole), make a 180-degree turn around pole 6, pass between pole 6 and pole 5, bend through the poles to pole 1, circle pole 1, bend through the poles to pole 6, make a 180-degree turn around pole 6, and cross the starting line by moving along the poles on the side opposite that on which they first approached pole 6.

A 5-second penalty will be assessed for each pole knocked down.

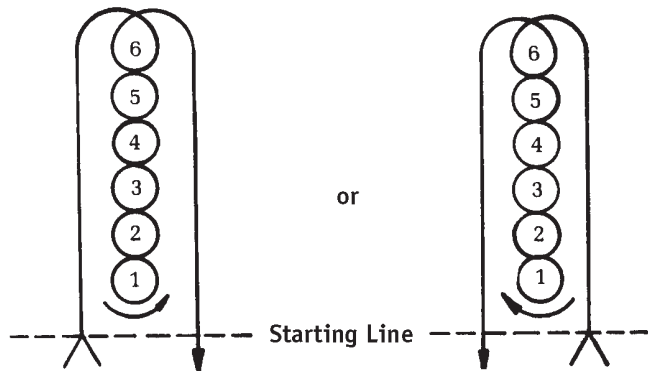

Figure 26. Pole bending course.

## Speed and Action

1. Seven kegs or markers are needed (see fig. 27). Using four of the kegs or markers, form a 12-foot by 24-foot box and mark lime lines between the kegs or markers on the 24-foot side. One 12-foot side will be on the starting line. The three remaining kegs or markers are to be placed at 7-foot intervals (from center to center) in a straight line parallel to and 200 feet from the starting line. These three kegs or markers must be at least 25 feet away from any fence.

2. The horse and rider are to start and end the course completely within the box. They may also start the course by entering through the top of the box (that is, by running through the box). Timing begins when the entry leaves the box and stops when the entry re-enters the box. The rider rides through the box to the kegs or markers 200 feet away, rides through two kegs or markers, circling the center one and

returning to the box. The rider must stop within the square of four kegs or markers.

3. There will be a 5-second penalty for each keg or marker knocked over.

4. Spinning to a stop more than 90 degrees in the box, as determined by the judge, will result in disqualification.

**Disqualifications** – Causes of disqualification include:

- Stepping over the line of the box at the end of the pattern.
- Not stopping forward motion in the box.
- Spinning to a stop (see #4 above).

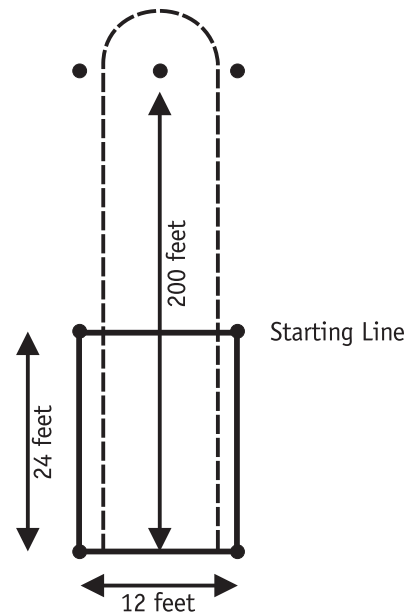

Figure 27. Speed and action course.

# Draft Horse Division

**NOTE:** In this division, “draft animals” include draft horses, mammoth donkeys and heavy mules.

## DRAFT HORSE CLASSES

### Fitting & Showing

**NOTE:** See the Fitting and Showing Division near the front of this book for more information on fitting and showing.

**APPOINTMENTS OF HORSE** – Horse should be shown in a white rope halter or flat nylon or leather halter with matching lead strap or appropriate white lead. Manes and tails should be combed out or decorated. No deductions are to be given to mares and fillies whose manes and tails have been decorated in the showmanship decorating class.

**APPOINTMENTS OF EXHIBITOR** – Exhibitors must be properly dressed, with neat, clean and strong footwear. Overalls, blue jeans and sneakers are prohibited. A hat, tam or other headgear is optional. Exhibitors may carry show sticks, but abusive use of show sticks will be penalized. Mammoth donkey and heavy mule exhibitors may carry crops.

Fitting & Showing Criteria	Points
<b>Appearance of horse</b> .....	<b>40</b>
Condition & thriftiness (15)	
Grooming (20)	
Tack (5)	
<b>Showing the horse</b> .....	<b>50</b>
Ring deportment/Leading (25)	
Actions (10)	
Posing (15)	
<b>Exhibitor presentation</b> .....	<b>10</b>
Attitude (5)	
Appearance (5)	
<b>Total</b> .....	<b>100</b>

### Criteria Explanation

#### APPEARANCE OF HORSE (40 points)

##### Condition and Thriftiness (15 points)

• See the “Appearance of Horse” section in the Fitting and Showing Division.”

### Grooming (20 points)

• See the “Appearance of the Horse” section in the Fitting and Showing Division.

### Tack (5 points)

Must be clean, neat, supple and properly fitted.

### SHOWING THE HORSE (50 points)

#### Ring deportment/Leading (25 points)

• Exhibitors should lead from the left side of the animal, holding the lead shank in the right hand about 6 to 12 inches from the halter. Smaller exhibitors may need a longer hold. Exhibitors of mammoth donkeys and heavy mules may carry a crop.

• The turn is made to the right the same as with light horses, but the turn is a keyhole loop instead of a pivot or tight turn.

#### Actions (10 points)

When moving, handlers should show off the animals’ knee and hock action. The action will be at a walk and a trot. Exhibitors of draft animals may use an adult trailer to make the horse move energetically forward when working individually for the judge. The trailer is selected by the exhibitor and must stay out of the way when not trailing.

#### Posing (15 points)

When posing, draft animals should stand quietly with their hocks close together. Exhibitors may use show sticks or hands on the animals’ shoulders to help place the feet when posing and to keep the animal’s attention. When posing at the end of the pattern, draft animals are usually posed at a three-quarter angle to the judge and with the animal facing uphill (see fig. 28). If showing with light horses, exhibitors should pose draft animals in the safest way possible.

### EXHIBITOR PRESENTATION (10 points)

#### Attitude (5 points)

- Businesslike and friendly.
- Cooperates with the judge, ring steward and other exhibitors.
- Concentrates on showing the horse and is not distracted by people and events outside the ring.
- Courteous, attentive and maintains a sportsmanlike attitude toward officials and other exhibitors.
- Portrays confidence in the horse’s training and in their own ability to present the animal.

#### Appearance (5 points)

Properly attired, neat, clean and with strong footwear.



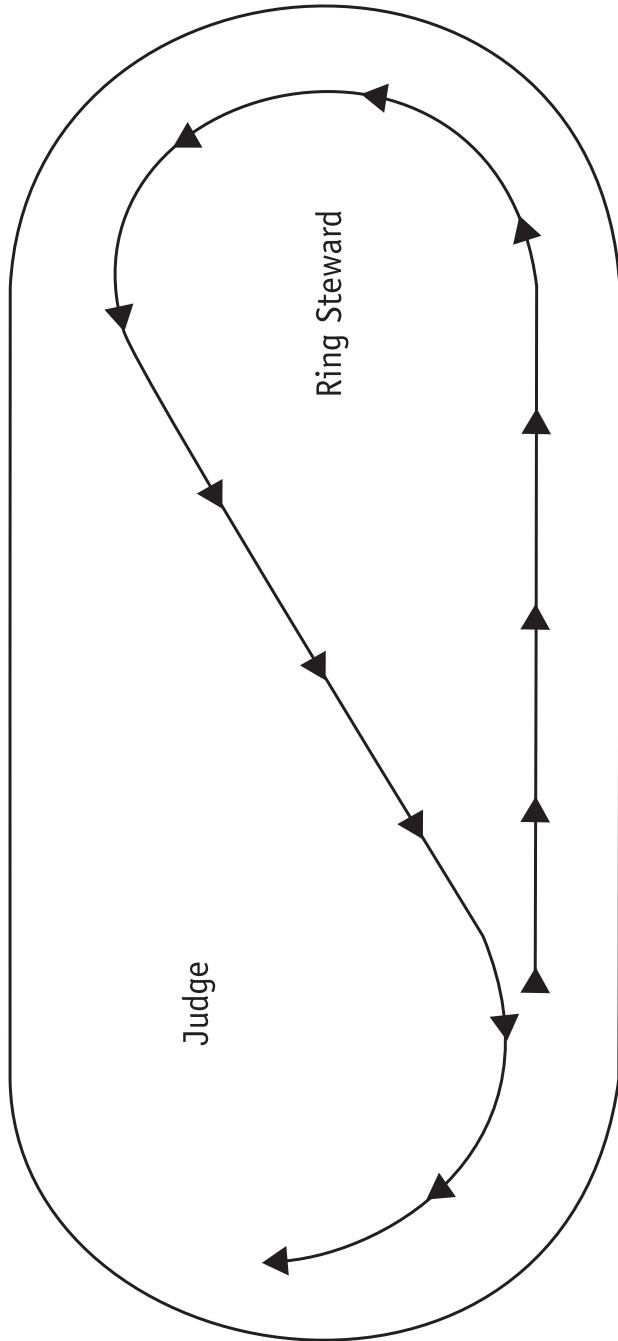

Figure 29. Reversing on the diagonal at the trot in draft horse pleasure driving.

**PERFORMANCE** – All entries will perform all gaits in both directions of the show ring, reversing on the diagonal at the trot (see fig. 29). All entries may be asked to back at the discretion of the judge. It is emphasized that this is a pleasure class and that a good entry is one that will provide a pleasant, responsive drive for a child driver.

**APPOINTMENTS** – Drivers must be neatly and appropriately dressed. Gloves are encouraged. A hat, tam or other headgear is optional. A whip must be carried in hand. An adult rider (swapper) is required for safety reasons.

Draft Horse Pleasure Driving Criteria	Points
<b>Movement</b> .....	<b>60</b>
The walk (10)	
The trot (30)	
Backing (20)	
<b>Manners</b> .....	<b>20</b>
<b>Responsiveness</b> .....	<b>20</b>
<b>Total</b> .....	<b>100</b>

**Criteria Explanation**

**MOVEMENT (60 points)**

**The Walk (10 points)**

True, brisk and relaxed.

**The Trot (30 points)**

True, square, and brisk, but under full control at all times. Extreme speed will be penalized. Natural action is desirable.

**Backing (20 points)**

A smooth, collected and straight back.

**MANNERS (20 points)**

The horse should be quiet on the bit, under control and work willingly on command without being sour.

**RESPONSIVENESS (20 points)**

The horse should perform all transitions smoothly and willingly. The horse should back showing submission to the driver and in a straight line.

**Draft Horse Driving Reinsmanship**

This class emphasizes the driver's ability to control his or her animal on the rail and through obstacles and other tests of driving ability. The

## DRAFT HORSE DIVISION

class should be first divided into junior and senior exhibitors and then by breeds if there are enough entries.

**APPOINTMENTS OF ANIMAL AND DRIVER** – Appointments of animal, driver and assistant driver or groom are the same as for draft horse pleasure driving.

Draft Horse Pleasure Driving Criteria	Points
Cleanliness & condition of horse, harness & vehicle.....	25
Rail work.....	25
Driving pattern.....	50
<b>Total.....</b>	<b>100</b>

### Criteria Explanation

#### **CLEANLINESS & CONDITION OF HORSE, HARNESS & VEHICLE (25 points)**

Horse is properly fitted, groomed and conditioned with a clean, crisp appearance. Attention is paid to the cleanliness of harness and vehicle. Proper and safe vehicle trappings (such as slow-moving vehicle sign, side lamp, whip basket and tool kit) are allowed.

#### **RAIL WORK (25 points)**

#### **DRIVING PATTERN (50 points)**

Drivers will be required to complete a driving test consisting of one or more of the following maneuvers:

- Drive through or around obstacles.
- Perform a figure 8 or turns within a 30-foot parallel, right and left showing the consistency of the speed, willingness and flexing of the horse on the turns.
- Fan (sidepass the animal in one direction 90 degrees, then 180 degrees to the opposite side, then returning to the starting point showing control, willingness and smoothness).
- Back up to a certain point or to back through obstacles.

## 🏇 Draft Horse Driving Working Class Single

**NOTE:** This class may need to be divided by types of vehicles or number of horses in the hitch. Conformation will not be judged.

**APPOINTMENTS OF DRIVER AND ASSISTANT DRIVER OR GROOM** – Long pants, long dresses, skirts, hard-soled shoes or boots are required. Ties, hats, gloves and jackets are optional. Blue colored jeans, overalls, work shoes, shorts, dresses and skirts are prohibited.

## DRAFT HORSE DIVISION

**APPOINTMENTS OF HORSE** – Any clean, safe and supple draft-type harness with breeching is acceptable. Rolled manes and scotch knot tails (when tails are docked) are recommended. Whips are mandatory. The driver of the vehicle will hold the whip. Unnecessary paraphernalia in the vehicle is prohibited.

**ROLE OF ASSISTANT DRIVER OR GROOM** – Each exhibitor must have an adult assistant driver or groom on the vehicle. The assistant must not give any voice cues or handle the reins or lines while moving to control the horse except in an emergency. The assistant driver or groom may dismount and help pose the horse or team of horses when coming into the lineup, but should stand at least two paces from the team during other class procedures.

### Draft Horse Driving Working Class Single Criteria Points

Performance & manners.....	75
Gaits (walk, trot, extended trot, jog trot) (50)	
Performance (25)	
Turnout of horse & vehicle.....	25
<b>Total.....</b>	<b>100</b>

### Criteria Explanation

#### **PERFORMANCE AND MANNERS (75 points)**

The driver has 3 minutes to enter the ring after the class is called. Each team is allowed up to two timeouts for a maximum combined allowance of 7 minutes of repair time. When a breakdown occurs, the horse is pulled to the center of the arena and repair time begins when the assistant dismounts from the vehicle. Time ends when the assistant remounts the vehicle. Exhibitors will be excused from the class if the repairs cannot be done in the allotted time.

#### **Gaits (50 points)**

The horse or team will be shown at the walk and trot in both directions of the arena and will be reversed at both directions.

#### **Performance (25 points)**

The judge may ask all or part of the class to do any of the following workoffs to help place the class:

- Backing the vehicle.
- Performing a figure 8.
- Reworking any or all gaits, but must include work at both directions for any gaits used.

Be sure enough space is available for drivers to complete workoffs safely. If space is tight, some of the class may be excused from the arena and then recalled.

#### TURNOUT OF HORSE AND VEHICLE (25 points)

- The horse is properly bitted, harnessed and manageable to the vehicle.
- The vehicle is properly hitched to the horse. Neat, clean and of safe construction for the driver and groom or assistant driver.
- Neat, clean overall appearance that is pleasing to the judge. No added decorations, sound utensils or distracting elements on the horse, harness, driver, assistant driver, groom or vehicle are permitted.

## Glossary

**ASTM-SEI** – The American Society for Testing and Materials – Safety Equipment Institute; the organization that sets specifications for safety helmets

**bit** – generally a piece of metal that is attached to a bridle and runs through the horse's mouth; used to signal the horse; bits are found in many styles and degrees of severity

**bosal** – braided rawhide or leather noeband used in lieu of a snaffle bit on horses aged 5 and under that curves around the nose and is knotted under the jaw; it is held on by a headstall and woven horsehair or rope reins are attached to the knotted heel of the bosal

**bradoon** – a small snaffle bit designed for use in a double bridle

**breed standards** – standards set by individual breed associations that describe the ideal representative of that breed

**bumping the reins** – a light check and release of the reins

**cavesson** – a noseband with two independent cheek pieces on the bridle

**conformation** – the build of an animal; the structure, form, balance and symmetrical arrangement of parts

**danger zone** – the area directly in front of or behind a horse in which it is dangerous to stand because of the danger of being kicked, struck or run over by the animal

**diagonals** – refers to the forefoot of the horse moving in unison with the opposite hind foot at the trot; when posting, the rider should rise as the forefoot on the outside of a turn comes forward

**dressage** – a style of riding whose object is the harmonious development of the physical ability of the horse resulting in a calm, supple, flexible animal, both longitudinally and laterally; evaluated by performing a specific performance test at the level of training the horse has accomplished

**drop the bit** – to remove the bit for the judge's inspection; always performed when the exhibitor is dismounted, usually before entering the ring or at the end of a class

**fashion heels** – heels on boots not designed for riding that may catch in a stirrup if a rider falls off a horse

**fault** – a decrease in points in an over-fences class, due to an error by horse or rider

**gait** – a way of going, either natural or acquired, that is characterized by a distinctive movement of feet and legs

**ground poles** – poles placed on the ground that a horse and rider may be called upon to go over

**gymkhana** – timed games on horseback with specific patterns and rules  
**halfbreed bit** – a curb bit with a 1½- to 2-inch port that often has a roller or cricket

**hunter hack** – class in which a horse and rider are called upon to go over two jumps individually and then perform work on the flat as part of a group

**impulsion** – In order to have impulsion, a horse must engage his hind legs and allow the energy to come through his elastic back\*

**judge** – impartial person hired or appointed by the show management to evaluate the performance of exhibitors at a 4-H horse show

**jump cups** – cup that holds a jump rail in place

**jump pins** – pin that holds a jump cup to a jump standard

**kimberwick** – a direct action English bit (see snaffle) that allows for the attachment of a curb chain, which can provide more of a leverage or curb effect

**lead (loping or cantering)** – the foreleg that is reaching out the furthest at a lope or canter; when circling to the right, the horse should be on the right lead, that is, the right foreleg should reach out slightly ahead of the left foreleg

**lead chain** – see “lead shank”

**lead shank** – a chain, rope, strap or combination thereof used for leading a horse

**longe** – the act of exercising a horse on the end of a long line, usually in a circle

**longe line** – line of not more than 30 feet long that may or may not have a chain at one end; used for longing a horse

**lugging on the bit** – the action of a horse that consistently pulls on the bit, against the rider or driver’s hands

**martingale** – a device used to assist in the placement of the horse’s head; a running martingale is a type of tiedown attached to the reins, a standing martingale is a type of tiedown attached to the cavesson or noseband

**mullen** – a bit with a straight or slightly curved mouthpiece that applies pressure across the horse’s tongue and bars only.

**near side** – the left side of a horse

**off side** – the right side of a horse

**overcheck** – a short rein passing from the bit to the saddle of a harness to prevent the horse from lowering its head

**overflexion** – a head and neck position in which a horse flexes its poll such that the muzzle is carried in toward the chest in an excessive manner

\* Harris (1993). *Horse Gaits, Balance and Movement*.

**pelham** – a one-piece bit equipped to handle four reins (two snaffle reins for guiding the horse and lifting the head and two curb reins for control and for setting the head)

**pumping the reins** – using the arms to pull heavily on the reins

**pylons** – markers or traffic cones used to designate a pattern; often bright orange

**ratcatcher** – a tie worn at the neck in English apparel; generally wraps around the collar and may be held in place with a pin

**ring steward** – the judge’s assistant; person who works with the judge, announcer, gate person and exhibitors to help ensure that a horse show runs smoothly

**romal** – an extension of braided material or smooth leather attached to closed reins

**rowels** – multipointed metal spur attachment that revolves

**safe/safety zone** – the area in front, but off to one side, of a horse; area where an exhibitor is not likely to be struck if the horse rears or lunges forward

**scratch** – when an exhibitor withdraws from a previously entered class before the class begins

**snaffle** – a very mild bit with a jointed or solid mouthpiece that works on direct pressure to the corners of the mouth (as opposed to a leverage bit such as a curb) and does not have shanks or curb straps

**snaffle rein** – the leather straps that attach to the snaffle bit and allow the rider to guide the horse; when used in a pelham or full bridle the snaffle rein is the heavier rein that is used for guiding

**sour ears** – a sign of agitation in a horse in which the animal pins its ear back

**spirit level (plumb bob)** – a device used for determining true horizontal or vertical directions by the centering of a bubble in a slight curved glass tube or tubes filled with alcohol or ether; used to ensure that jumps are level; also called level

**splint boots** – protective boots worn on the horse’s front legs to prevent injury to the cannon bones

**stock tie (or pin)** – a tie or pin worn at the neck in western or English riding apparel

**tack** – riding equipment or gear for the animal such as a saddle, bridle, halter

**traces** – the parts of a harness that run from the collar to the singletree

**trailer** – an assistant to the exhibitor in a halter class who encourages draft horses and donkeys to move out energetically



# Suggested Changes to 4-H Horse & Pony Project Show Rules & Regulations

Please return the completed form to:

Equine Youth Extension Specialist  
Michigan State University  
1287J Anthony Hall  
East Lansing, MI 48824  
Fax: 517-353-1748

Please print or type and add additional pages if needed. Only one suggested change per form, please.

Name: \_\_\_\_\_

County: \_\_\_\_\_

Address: \_\_\_\_\_

Daytime Phone: ( \_\_\_\_\_ ) \_\_\_\_\_

E-mail: \_\_\_\_\_

Suggested Change: \_\_\_\_\_

\_\_\_\_\_

\_\_\_\_\_

Location of recommended change in current book:

Page: \_\_\_\_\_ Paragraph: \_\_\_\_\_

Suggested Wording: \_\_\_\_\_

\_\_\_\_\_

\_\_\_\_\_

\_\_\_\_\_

\_\_\_\_\_

\_\_\_\_\_

\_\_\_\_\_

Reference Material:

\_\_\_\_\_

\_\_\_\_\_



\_\_\_\_\_

\_\_\_\_\_



## Mission Statement

Michigan 4-H Youth Development involves volunteers in providing positive, experiential, educational opportunities for and with youth. Our mission is to create environments, through collaboration, that build strong, healthy youth who are proactive in a complex and changing world.



MSU is an affirmative action/equal opportunity employer. Michigan State University Extension programs and materials are open to all without regard to race, color, national origin, gender, gender identity, religion, age, height, weight, disability, political beliefs, sexual orientation, marital status, family status or veteran status. Issued in furtherance of MSU Extension work, acts of May 8 and June 30, 1914, in cooperation with the U.S. Department of Agriculture. Thomas G. Coon, Director, MSU Extension, East Lansing, MI 48824. This information is for educational purposes only. Reference to commercial products or trade names does not imply endorsement by MSU Extension or bias against those not mentioned. The name "4-H" and the emblem consisting of a four-leaf clover with stem and the "H" on each leaflet are protected under Title 18 U.S.C. 707. Printed on recycled paper. 6R-1P-03:11-PDF-RM